

HA-VGW Intelligent Security System

User manual



Brief

Thank you for purchasing the 'smart home' products of our company, we hope our products can bring convenience and protection of your safety. The 'smart home' system uses the most advanced digital sensing and control technology. It is a set of smart alarm control system of anti-theft, anti-fire, and anti-gas leak compatible with wired and wireless alarm. The 'smart home' products can connect mobile phone APP and platform through accurate and simple WiFi connection mode, realize remote control and wireless alarm mode to push message to users. It is safe and simple, and mastering the surrounding environment information at any time. It is the best choice for modern security and anti-theft alarm products. This product is easy to operate and easy to learn with voice indication all around the operation. Complicated orders are not needed.

The 'smart home' system recommends the most advanced multi-random vault technology in safety and reliability, which effectively solve the problem of interference, false positives, false negatives that can not be solved by similar system at present. The way the 'smart home' system uses in the alarm signal on the common high-speed way CONTACT ID makes application of this series of products wider and compatibility stronger. The system can be widely used in family, community, villas, shops, units and so on.

We recommend that you carefully read the instruction to facilitate you for a skilled operation and use to the product, so the product can better serve you.

We will not notice if there is a change of product performance, if you want to know the latest features, please contact with the relevant business.

Table Of Contents

Chapter I Product Introduction	1
Chapter II Installation and Connection	4
2.1 Installation For the Alarm Control Panel	4
2.2 SIM card and TF card inserted	4
2.3 Connection	5
2.4 Install wired detector	5
2.5 Install wireless detector	5
Chapter III Key description and Basic operation	6
3.1 Key description	6
3.2 Basic operation	7
3.3 LCD icon	8
3.4 System Arm and Disarm	9
3.5 Alarm procedure	10
Chapter IV Voice Alarm Receiving And GSM Control	11
4.1 Remote phone control	11
4.2 Alarm receiving phone operation	11
4.3 GSM control via SMS	12
Chapter V User Settings	13
5.1 Set User Password	13
5.2 Set Voice Phone	13
5.3 WiFi config	13
5.4 Add Cameras	18
5.5 Camera Binding Host	18
Chapter VI System Setting	20
6.1 Set password	20
6.2 WiFi	21
6.3 Set Network	21
6.3.1 DHCP	22
6.3.2 Host IP	22
6.3.3 Network gateway	22
6.3.4 Subnet mask	23
6.3.5 Preferred DNS	23

6.3.6 Standby DNS	23
6.3.7 WEB port	24
6.4 Set CMS	24
6.4.1 Phone CMS Enable	24
6.4.2 CMS Phone No. 1	24
6.4.3 CMS Phone No. 2	25
6.4.4 CMS user Number	25
6.4.5 CMS Dialing Times	25
6.4.6 Internet CMS Enable	26
6.4.7 Sever IP	26
6.4.8 Sever Port	26
6.4.9 Sever Account	26
6.4.10 Sever Password	27
6.4.11 Sever Heartbeat	27
6.5 Set Voice Phone	28
6.5.1 Set voice phone number	28
6.5.2 Dialing times	28
6.5.3 APP Server IP	29
6.6 System options	29
6.6.1 Entry Delay	29
6.6.2 Exit Delay	30
6.6.3 Siren Time	30
6.6.4 Sensor loss	31
6.6.5 AC off Delay Time	31
6.6.6 Comm Test	32
6.6.7 Arm/Disarm Tone	32
6.6.8 Arm/Disarm Report	32
6.6.9 Force Arming	33
6.6.10 Door Open Check	33
6.6.11 Sensor Tamper Check	34
6.6.12 Alarm Times	34
6.6.13 Emergency Siren Type	34
6.7 Wireless	35
6.7.1 Wireless Remote	35

6.7.2 Wireless Sensor	36
6.7.3 Wireless Switch	37
6.7.4 Wireless Siren	38
6.7.5 Wireless doorbell	39
6.8 Zone Management	40
6.9 Set Alarm Alert	41
6.10 SmartHome	43
6.11 Time	44
6.11.1 Auto time	44
6.11.2 Daylight-saving time	45
6.11.3 24-hour system	45
6.11.4 Time zone	45
6.11.5 Time	46
6.11.6 Timing Arm/Disarm	46
6.12 Restart	47
6.12.1 Restart	47
6.12.2 Delete logs	47
6.12.3 Factory default	48
6.13 Display	48
6.14 RFID	48
6.15 Others	49
6.15.1 Recording	49
6.15.2 Play	50
6.15.3 PGM	50
6.15.4 Chime Music	50
6.16 Corss zone	51
6.17 About	51
Chapter VII Technical Specification	52
Chapter VIII Maintenance	53
Chapter IX Limitation of the Products	53

Chapter I Product Introduction

1. Alarm Mode: With Internet network and GSM network alarm, GSM network with GPRS function, remote arm and disarm panel through CMS or SMS, CID protocol, SMS notification, the priority of Internet Network and GSM Network is Optional.
2. With a new color-screen, full-touch buttons, LCD graphic display steps, working status, alarm process easy and intuitive.
3. The full english voice prompting operation: all local or remote operation, alarm information, event log view.
4. GSM-hook and voice telephone with intercom function.
5. All alarm information can be programmed by 16 ways.
6. Sleep mode, in sleep mode status, all the lights, LCD backlight, voice and prompt tone are disabled.
7. Alarm panel under idle status is equivalent to a cellphone, you can call through the GSM network for balance inquiries.
8. 8 groups associated zone, can effectively reduce false alarm or for other functions.
9. PGM output: With a programmed output port, followed by 5 kinds of alarm events output.
10. The Doorbell Audio Optional: 1. Ding Dong 2. Welcome
11. Remote Phone operation: dialing by telephone offsite, after password verification, you can arm, disarm, listen-in premise, system status query and electrical switches controls and other operations.
12. Voice Alarm: When panel alarm, it will automatically dial the preset user phone numbers to report alarm information then you can remote control the panel after enter user passwords.
13. 32 wireless zones, each wireless zone can automatically learn the codes or be coded manually via the keyboard and web operation.
14. 8 wired zones, user can set the circuit type and speed of response, support N.O, N.C.
15. Enable enroll total 8 wireless remotes, 16 electronic switches, 1 wireless doorbell and unlimited for quantity of one way wireless siren, 16 RFID tags.

- 16.** 6 follow me phone # (voice alarm receiving phone #), 2 for CMS, 4 for private alarm receiving.
- 17.** Status Inspection Functions: enable record and inquiry 512 alarm event messages. Like the time when happens anti-tamper alarm, detector alarm, tel-line off, arm, disarm, system setting, battery low voltage ect. And also can inquiry the zone number and alarm type.
- 18.** Timing Arm/Disarm: 4 sets of timing arm and disarm time.
- 19.** Electrical Switches Control: User can remote switch on/off via phone or SMS, also can be controlled manually through the local alarm panel.
- 20.** Zone Programmable: factory preset for each zone type. Users can modify all the zone type according to the actual needs .
- 21.** Clock: Built-in full automatic calendar clock, set to local time consistent.
- 22.** Password Access Management: the panel has one administrator password 16 user password, The administrator password primarily for system administrators to set up the alarm system; The user passwords for users in the day-to-day use such arm/ disarm, remote operation. The administrator password, user password can be freely modified.
- 23.** For CMS networking alarm, depending on the number of users, the user can set four user codes(account number).
- 24.** Zone type identification: After an alarm is triggered, the alarm zone number displayed on the LCD screen of the panel, also can send the detailed report to CMS which includes alarm locations and zone types.
- 25.** Alarm mode: stand-alone single-family use by the ordinary telephone alarm; it can also be connected to the Internet with the alarm center by the computer alarm. Alarm center automatically recognize and compatible with ordinary telephone alarm.
- 26.** The tampering alarm: cut the cable between wired detectors and the panel will trigger alarm.
- 27.** Anti-tamper function: When someone deliberately dismantled the panel, it will alarm when triggering tamper switch at the back of the panel.
- 28.** CMS communications test: The panel will send a message to CMS at the pre-set time interval to inspect the communication if normal.
- 29.** Siren options: Built-in siren, external wired siren, Wireless siren. All sirens can be programmed as enabled/disable when alarms.

30. The voice speaker volume adjustment: total 7 level, adjust the volume by a panel arrow keys.

31. Wireless repeater function: can extend the distance between the detector and the panel by adding a wireless repeater of our company.

32. The wireless detector low battery prompted: Detectors will send status report to the panel every 1-3 hours, the corresponding zone number and the battery voltage symbol will be displayed on the LCD screen and also will report to CMS.

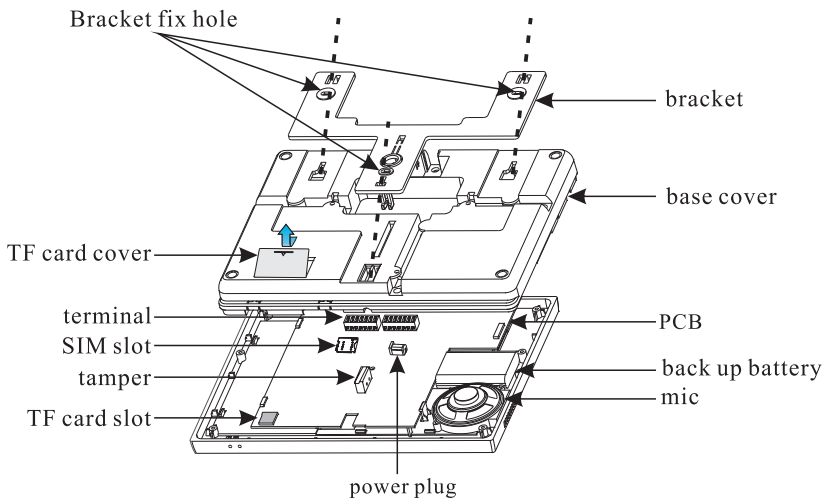

Fig.1-1

Chapter II Installation and Connection

2.1 Installation For the Alarm Control Panel

1. Fix the bracket to the wall and hang the panel to the bracket.

Please refer to the below steps:

A. Push the bracket up to loosen and remove the bracket, like Fig. 2-1:

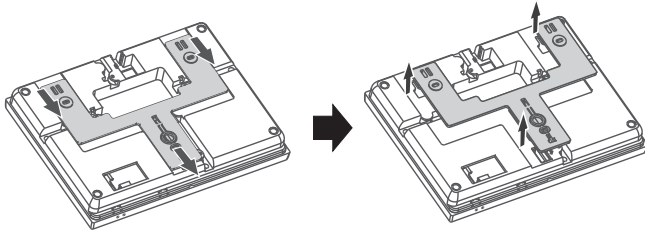

Fig. 2-1

B. Use screws to secure the bracket to the wall.

C. Align the panel with the bracket, hang it on the wall and push it down tight, as pictures.

2. The large metal objects can not be placed around the panel, so as not to affect the wireless signal.

3. Make sure to place the panel within the wireless range of all wireless accessories and pay attention to the hidden.

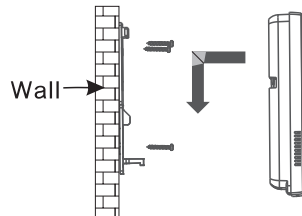

Fig. 2-2

2.2 SIM card and TF card inserted

① Please insert the SIM card in the shut-down state of panel, the side with the disk facing down, then push the SIM card into the slot, as Fig. 2-3.

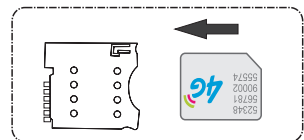

Fig. 2-3

② TF card installation

A. Remove the front cover ;

B. Insert as Fig. 2-4.

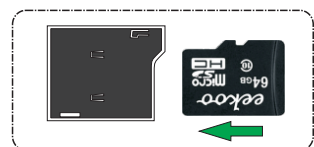
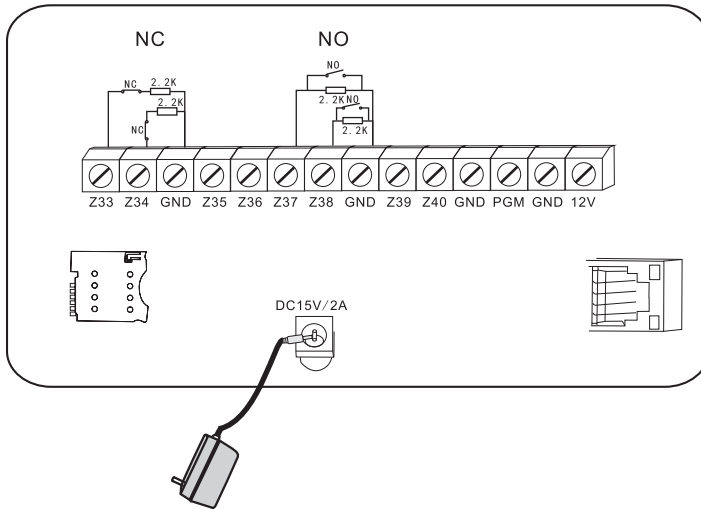

Fig. 2-4

2.3 Connection (The wired zones support N.O.N.C detectors)

As pictures



Here only introduce the zone 33,34,37,38. The other zones please refer to the above.

2.4 Install wired detector

2.4.1 The wired zones is disabled factory default. When to use wired zones, please enable the zones firstly. When wired zones is in trouble, the panel will voice prompt "operation failed, Zone trouble" if users try to arm the panel. The zone number will be also display on the LCD screen. At this time arm system is not allowed unless you force arm.

2.4.2 The control panel can power 15V, 100mA to detectors. The max current is 100mA. Do not exceed 100mA, otherwise please use extra power supply.

2.5 Install wireless detector

2.5.1 As the detector's manual says, install coded detector in the area 150m from the control panel. Please make the walk testing and make sure detector can work with control panel normally.

2.5.2 Wireless repeater function: (product item No. PB-205R) when wireless detector is too far from the panel or some occluders between panel and detector which disable the panel receive the signal from wireless detector. Now you can choose the repeater to make wireless repeater to achieve wireless signal relay transmitting.

Chapter III Key description and Basic operation

3.1 Key description

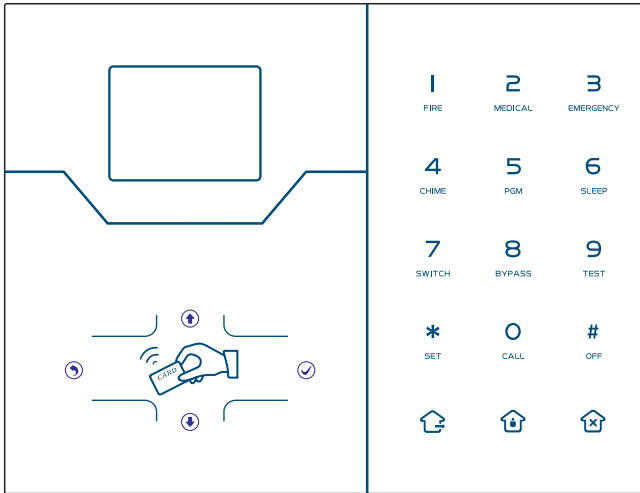

	Arm
	Home Arm
	Disarm
	RFID Card
	Up key
	Down key, System status/zone status/event log inquiry key
	Return key, volume reduction
	Confirm key, volume plus

1 FIRE	Press 3 seconds to trigger fire alarm
2 MEDICAL	Press 3 seconds for medical help
3 EMERGENCY	Press 3 seconds for SOS
4 CHIME	Press 3 seconds and enter user code to enable or disable delay zone door bell
5 PGM	Press 3 seconds then enter user code to enable or disable PGM output
6 SLEEP	Press 3 seconds to enter or exit sleep mode
7 SWITCH	Press 3 seconds then enter user code to enable or disable electrical power switch
8 BYPASS	Press 3 seconds then enter user code to bypass zones or activate zones
9 TEST	Press 3 seconds then enter user code to proceed normal testing,siren testing and walk testing
0 CALL	Press 0 for 3 seconds to make phone call through GSM, the talk time up to approximately 240 seconds
* SET	Set/Select down key
# OFF	Confirm/Open options key

Sleep mode: all LED indicators,backlight,voice,remind tone will be disabled under sleep mode, The panel will exit sleep mode automatically when users enter system setting or when alarm occurs.

Bypass zone: bypassed zones means zones disabled.Bypass zones will be canceled when users disarm systems under home armed or armed status.

Communication test: To test the communication between the panel and the CMS if normal.

Siren test: To test if siren working normal.

Walk test: To test if the detectors are working normally with the panel and alarm.

3.2 Basic operation

Factory default

Administrator password: 012345

16 User passwords,No.01 factory default is 1234.No.02-16 of the user password is blank and can not enter the user setting until user set the password.

Disarm: User password [1234]+Disarm key 

Home arm: Home arm key 

Arm: Arm key 

Event Log: Press Down key  to choose event log + 

Shutdown: AC power off firstly, in disarm status, Press # key for 3s, enter 1234# command.

Enter System Setting: Press * key for 3s, enter admin password 01235# command.

Enter User Setting: Press * key for 3s, enter 1st user password 1234# command.

Zone Inspection: Within 60s of AC power on, the system do not inspect wired zones.













Forget Password: Shutdown firstly, within 60s of AC power on, press * key for 3s, enter 000000# command to reset.

Zone Inspection: Do not inspect wired zones within one minute of panel power up.

Notice: Only under disarm status of panel, enter system settings and user settings.

3.3 LCD icon



Icon	Meaning	Icon	Meaning
	GSM signal strength		WiFi
	Enable Internet CMS		APP control
	Power supply		Built-in battery level
	Arm		System disarm
	Home arm		Temperature
	Fault prompt		Zone status

1.System fault display: Icon “

2.Zone fault display: When the zone fails, Zone status corner icon shows the number of zone faults, the text below the icon shows the fault function. When the fault is removed, the icon shows “zone normal”.

The details of the faults can be queried by entering the user settings.

When panel alarm and user disarm, the screen still shows zone alarm, please disarm again, and the screen shows the zone normal.

3.4 System Arm and Disarm

☆ ARM

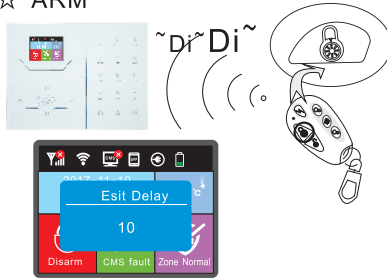

Press the arm key on remote or the keypad, then you hear system armed, please exit the protection area there will be Di-Di sound to confirm the system is armed successfully.

☆ DISARM

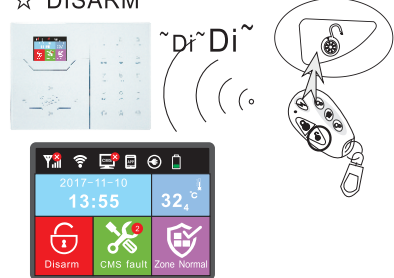

Press the disarm key on the remote or enter your user password on the keypad, then you will hear Di-Di and voice "system disarm", then you have disarm successfully.

☆ HOME ARM

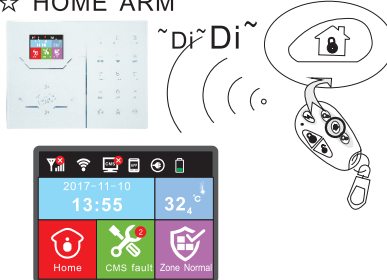

Press the key for home arm on the remote or HOME key on the keypad, then you will hear 'system stay' and it display home arm icon on the LCD screen.

☆ SOS

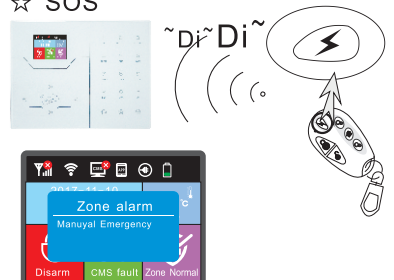

Press the panic button on remote, or press 3 key on panel for 3 seconds, it will trigger to alarm.

The codes of arm/disarm via different ways:

Arm/disarm via remote controllers: 1-8 remotes----#40-47

Arm/disarm via user codes: 1-16 user codes----#01-16

Arm/disarm via phone call: 1-4 user phone number ----#50-59

Arm/disarm via CMS: #60

Arm/disarm via auto timer or key zone: #80-81

Arm/disarm via RFID Card: #20-39

Arm/disarm via WEB Page: #70

Unknown control: #90

3.5 Alarm procedure

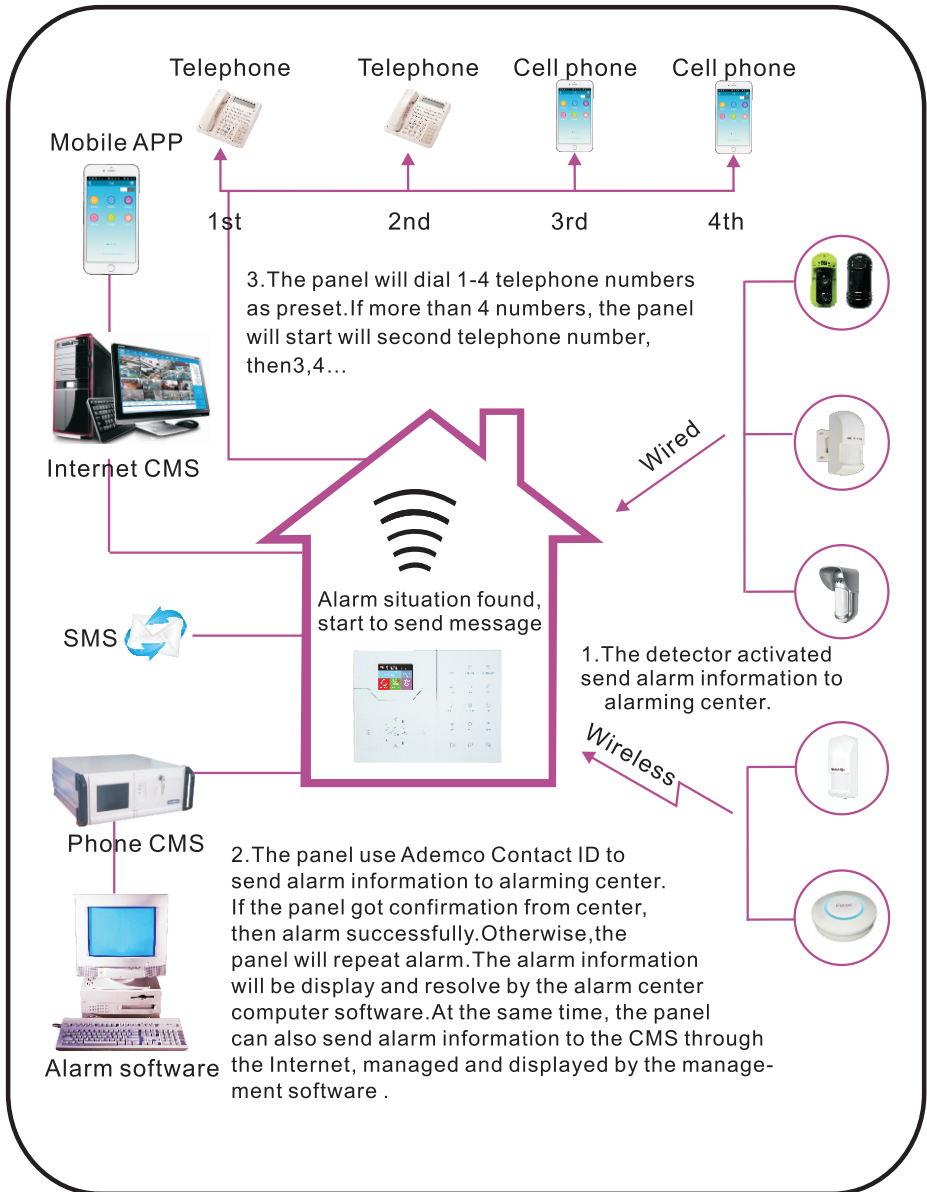

Chapter IV Voice Alarm Receiving And GSM Control

4.1 Remote phone control

User make phone call to the GSM No.of the alarm control panel.Directly connect to the alarm control panel,according to the voice prompt to enter the user password as below photo.

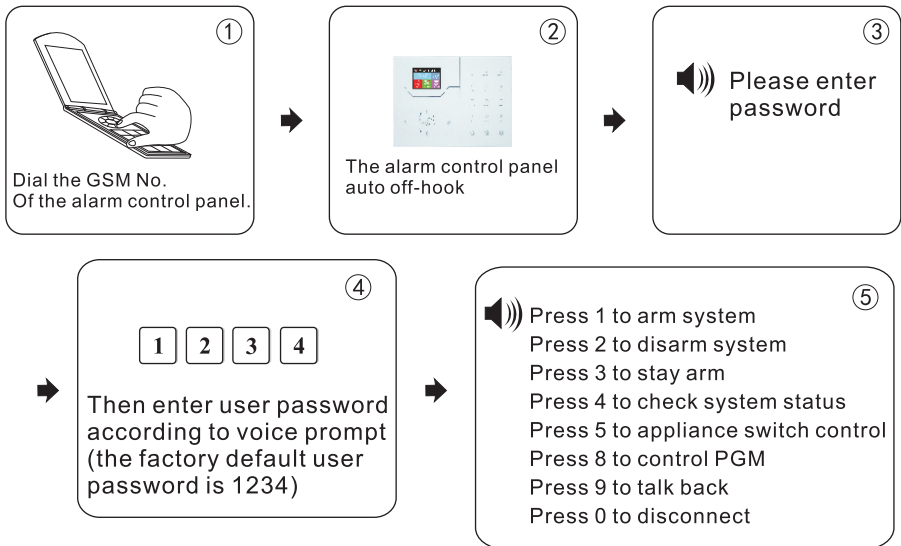

4.2 Alarm receiving phone operation

When alarm,the panel will dial the preset voice phone number,when the user pick up the call,they will hear the voice prompting as below, if not press 1 to cancel the alarm or press 4 to disarm the system,after off-hook,the panel will call other preset voice phone numbers.

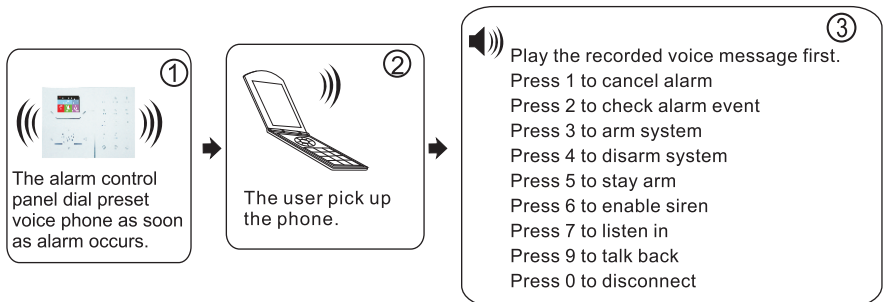

4.3 GSM control via SMS

Arm Command	#PWD1234 # ARM
Disarm Command	#PWD1234 #DISARM
Home Arm Command	#PWD1234 # HOME
Status Checking command	#PWD1234 # CHECK
Enable programmable output port	#PWD1234 # PGM OPEN
Disable programmable output port	#PWD1234 # PGM CLOSE
Enable appliance switch command	#PWD1234 # SWITCH OPEN XX (XX=01-16 on behalf of appliance switch number)
Disable appliance switch command	#PWD1234 # SWITCH CLOSE XX (XX=01-16 on behalf of appliance switch number)

Note:

1, the factory default user code is 1234, when arm successfully, SMS auto reply ‘ arm successfully’ , if the password is correct, the command is not correct, SMS will reply ‘ operation failure’ , if the password is not correct, no SMS reply.

2, 'FOR Enable/disable the appliance switch

#PWD1234 # SWITCH OPEN **XX(01-16)**

XX is for electric switch serial number from 01-16, there is space between ‘ OPEN’ and ‘XX’

Chapter V User Settings

Press [*] for 3 seconds

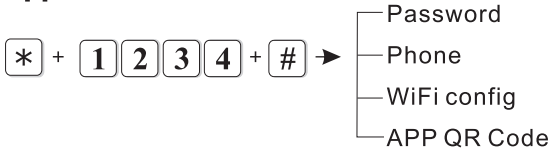

5.1 Set User Password

For example: set No.2 use password as 5678

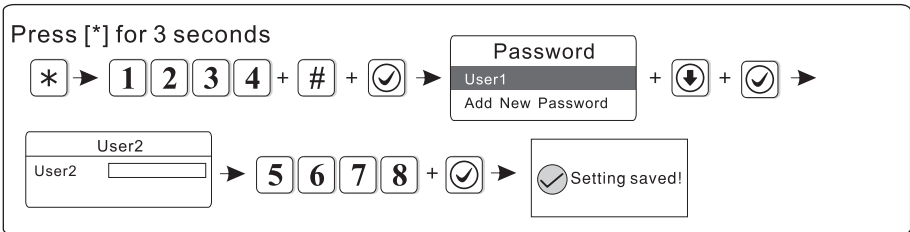

Note: Can set 16 user passwords, corresponding password No. From 01 to 16, Only No.1 password can enter user setting.

5.2 Set Voice Phone(refer to 6.4)

5.3 WiFi config

Pls scann and download app to your smart phone before wifi configuration.



Android



iPhone

Click the icon below to enter settings.



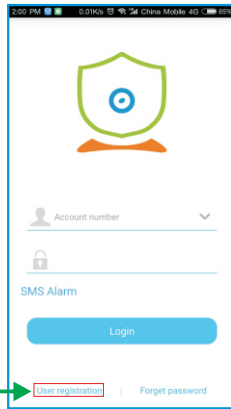

Fig. 5-1

For new users,
please click
"user registration".

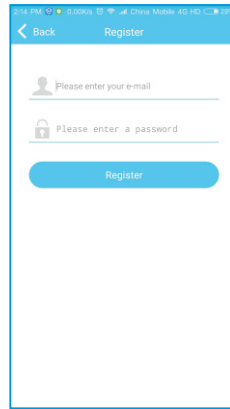

Fig. 5-2

Click the app to enter login interface .

User name: (EMAIL)

Password: (set as you like)

After setting, please enter the code and click "Register".

After the registration is successful, the interface will automatically jump to the login interface, and the user clicks on login. (Fig. 5-1, Fig. 5-2)

The panel connect to the WiFi Network by ways of Smart Configuration and Hotspot. Following operations will take andriod app as example. IOS version similar to the below steps.

Method 1:Smart Configuration

Step 1. Press and hold the  for 3 seconds,

voice prompt: please enter password,

input 

enter smart config interface to enable the smart phone configuration mode.



Step 2: Mobile phone connected to WiFi, log in to the registered account and enter the device add interface, Fig.5-3,5-4,5-5.



Fig. 5-3



Fig. 5-4

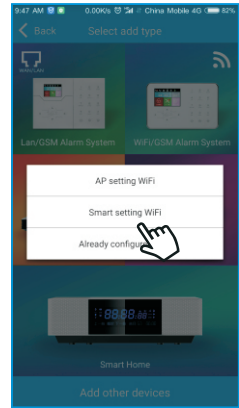

Fig. 5-5

Step 3: Enter the name and password of the WiFi to be connected(Fig. 5-6), click “Start Config”, and click Host when the host screen displays “Configuration Successful”(Fig. 5-7).

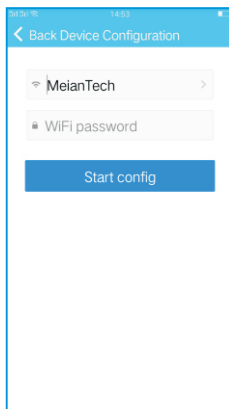

Fig. 5-6

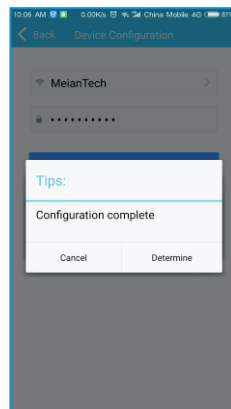

Fig. 5-7

Step 4: After the configuration is completed, the scanning interface is automatically entered.

Press and hold the host for more than 3 seconds, the voice prompts "Please enter the password".

Input + # +

Open the QR code of the APP and scan it. After the scan code is successful, you can add the host to the APP. (Fig. 5-8, 5-9, 5-10)



Fig. 5-8

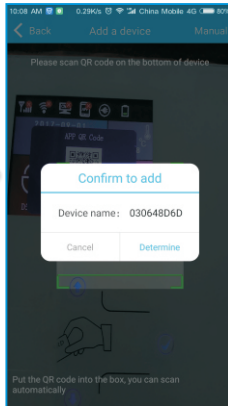

Fig. 5-9

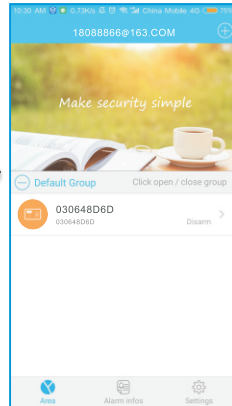

Fig. 5-10

Method 2: AP setting WiFi

Step 1: Log in to the registered account, enter the device add interface - WiFi/GSM alarm System, select "AP setting WiFi". (Fig. 5-11)

Step 2: Enter the available WiFi name and password in the hotspot setting WiFi interface (Fig. 5-12), click to start configuration, and the pop-up window prompts the operation steps. (Fig. 5-13)

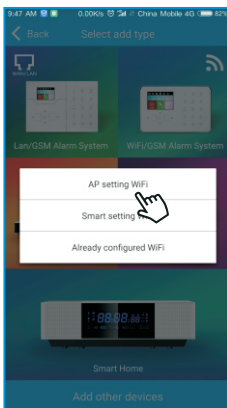

Fig. 5-11

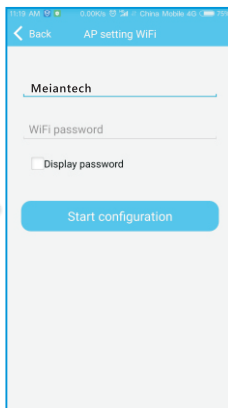

Fig. 5-12

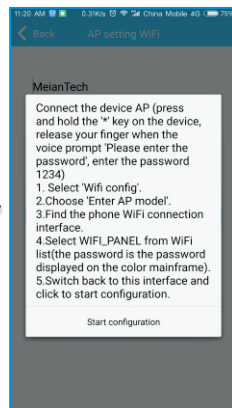

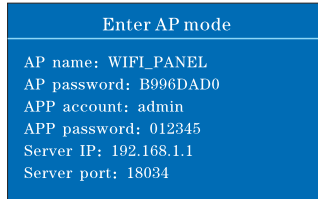

Fig. 5-13

Step 3: Press and hold the host  For more than 3 seconds, the voice prompts "Please enter the password".

Input     +  +    +  

Enter AP mode;



Step 4: Open the phone WiFi settings, select the hotspot name and enter the hotspot password to connect; switch to the phone configuration interface and click "Start Configuration" (Fig. 5-11, 5-12, 5-13) .

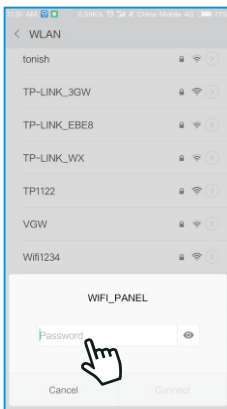

Fig. 5-11

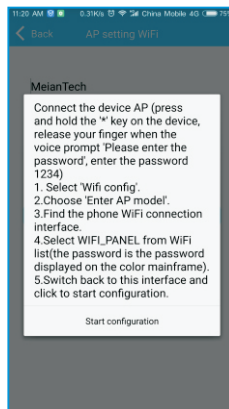

Fig. 5-12

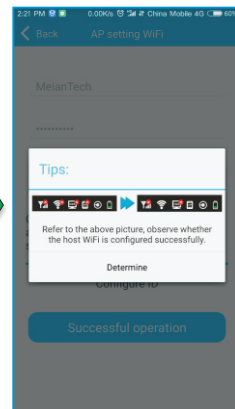

Fig. 5-13

After the configuration is completed, the host color screen is displayed to indicate whether the WiFi is normal. Click "OK" to enter the scanning QR code to add the host interface. Please refer to Method 1 in step 4.

5.4 Add Cameras

Click the icon "⊕" in the device list - click "Network Camera" in Fig.5- 4 to enter the camera add interface, you can add the camera by manual input and scan code to add devices:

Scan: click IP camera, scan the QR code label on device(Fig.5-14), add successfully windows pop up, click confirm.

Manually: click IP camera, click manual to enter manually adding interface, as Fig. 5-15.



Fig. 5-14

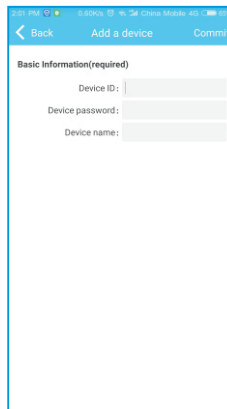

Fig. 5-15

Device ID: The ID # under the QR code

Device Password: default 123456

Device name: Programmable

Click commit

Note: Refer to the camera manual for details on how to use the camera.

5.5 Camera Binding Host

Camera binding needs to be done while the camera has been added to the APP and the camera is online.

After the camera is bound to the host, triggering the bound zone alarm will automatically pop up the video.

Click on the online host to enter the cloth withdrawal operation interface (Fig. 5-16), select Settings button > Zones (Fig. 5-17) > Zone 1 (Fig. 5-18), enter the name of the Zone, select Zone type and Alarm type, click "Bind device", tick the camera to be bound and save, return to Preventive Zone 1 and click "Save" to take effect. (Fig. 5-19, 5-20, 5-21)

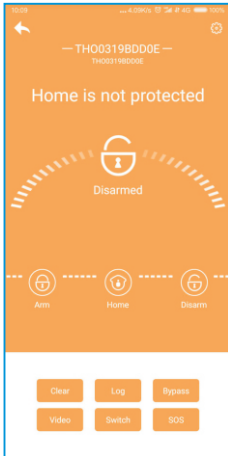

Fig. 5-16

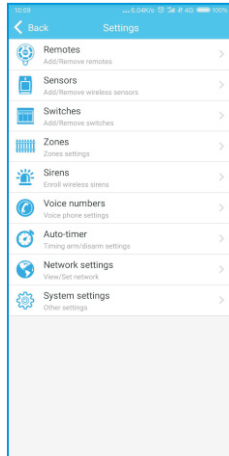

Fig. 5-17

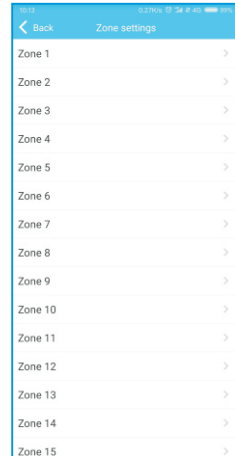

Fig. 5-18

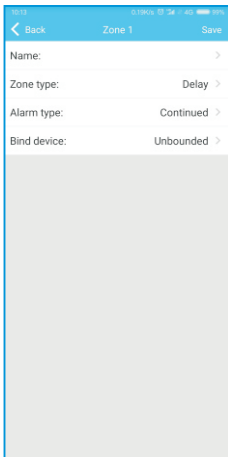

Fig. 5-19

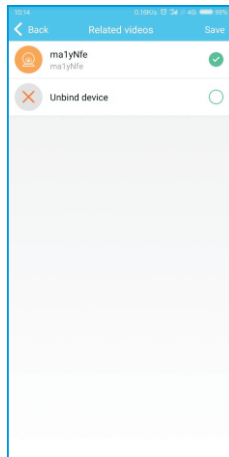

Fig. 5-20

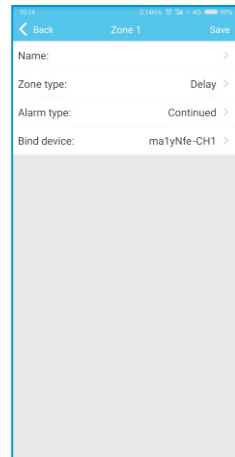
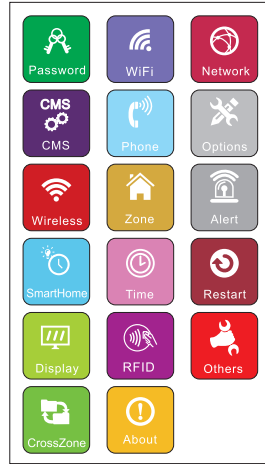

Fig. 5-21

Chapter VI System Setting

Press[*]for 3 seconds, voice prompt “please enter password”

* + 0 1 2 3 4 5 + # →



6.1 Set password

Press[*]for 3 seconds, voice prompt “please enter password”

* + 0 1 2 3 4 5 + # + [Down Arrow] [Checkmark] the following operations can be performed :

①Set admin password

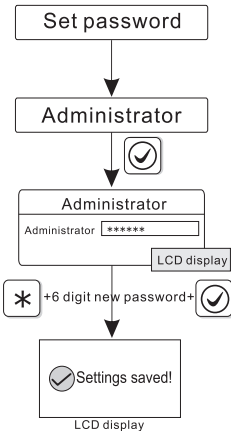

②Set user 1 password

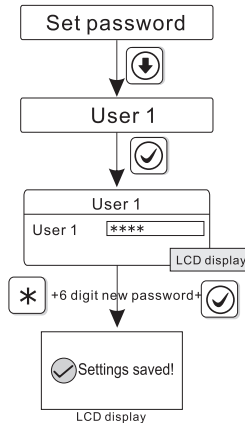

③Add new password

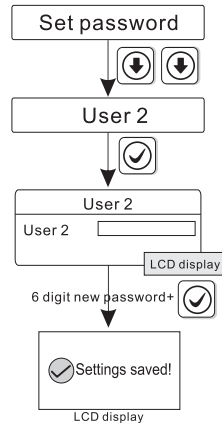

Note: Password setting is included user password and administrator password. user password mainly use to disarm the system, it is a private key for remote controlling, Administrator password is the sole password to set the system.

2. Administrator password is 6 digit, user password is 4 digit, can set 16 user password, corresponding password No. from 01 to 16, but No.02-16 password can not enter user setting.

For example: Set admin password as 888888

Press[*]for 3 seconds

* → Enter password + 0 1 2 3 4 5 + # + [Down Arrow] [Up Arrow] + *

+ 8 8 8 8 8 8 + [Checkmark] → [Settings saved!]

After the setting is completed, the screen will automatically return to the upper interface

LCD display

Note:1. Above base on the correct operation, if incorrect operation occurs, please press back key to back previous menu.

2. The factory default of admin password is 012345, user password is 1234, if you have modified the password, please refer to the new password.

6.2 WiFi

Press [*]for 3 seconds, voice prompt "please enter password"

* + 0 1 2 3 4 5 + # + [Down Arrow] [Down Arrow] [Checkmark] →

- SmartConfig
- Enter AP mode
- Exit AP mode

WiFi connection method is described in "5.3 WiFi config".

6.3 Set Network

Press [*]for 3 seconds, voice prompt "please enter password"

* + 0 1 2 3 4 5 + # + [Down Arrow] [Checkmark] →

Press 3 times

- DHCP
- IP
- Gateway
- Subnet Mask
- Preferred DNS
- Alternate DNS
- Web Port

Note: Just can set host IP, gateway, subnet mask and DNS when DHCP is disabled.

6.3.1 DHCP

Enabled DHCP means using DHCP server to assign IP address, subnet mask and default gateway automatically.(default is enabled)

For example: Disabled DHCP

Press[*]for 3 seconds

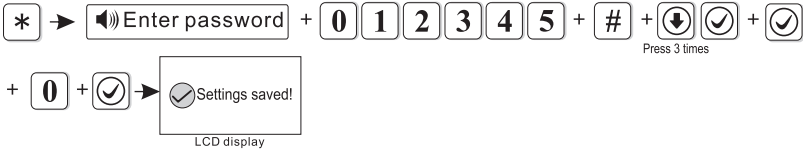

0 is disabled,1 is enabled

After the setting is completed, the screen will automatically return to the upper interface.

6.3.2 Host IP

- ①The default DHCP function is enabled, please disabled DHCP when you set host IP.
- ②User need to set up the network parameters according to the actual network environment . when there are more panels in the same network, the IP of panels must be different.
- ③Setting the IP address, if it is not enough 3 digits, please fill in the 0 before the digits,for example "192.168.1.81", need to enter "192168001081" from keypad. after setting IP address, then exit system setting and auto restart to make the setting in valid.*Note: when DHCP is enabled, this setting is invalid.*

For example: Set IP as 192.168.3.82

Press[*]for 3 seconds

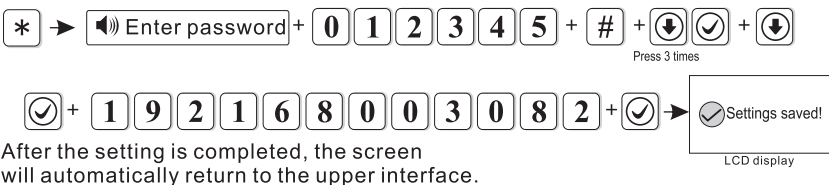

After the setting is completed, the screen will automatically return to the upper interface.

6.3.3 Network gateway

User can set network gateway according to the local actual conditions, for example:set gateway as 192.168.3.1

Press[*]for 3 seconds

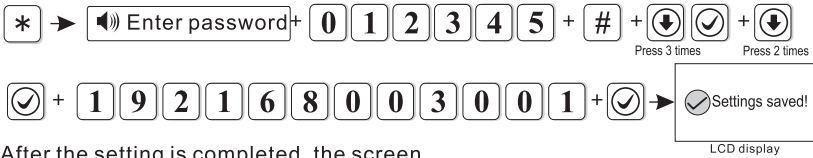

After the setting is completed, the screen will automatically return to the upper interface.

6.3.4 Subnet mask

For example: set Subnetmaks as 255.255.255.240

Press[*]for 3 seconds

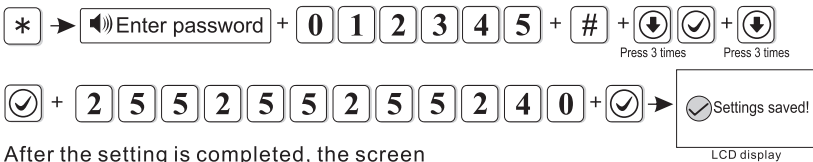

After the setting is completed, the screen will automatically return to the upper interface.

6.3.5 Preferred DNS

For example: set preferred DNS as 202.096.128.086

Press[*]for 3 seconds

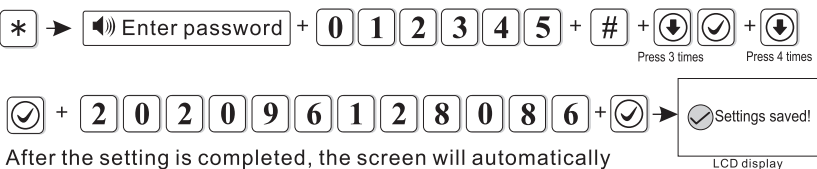

After the setting is completed, the screen will automatically return to the upper interface

6.3.6 Standby DNS

Please refer to the above operation method.

6.3.7 WEB port

Please refer to the above operation method.

6.4 Set CMS

Press [*] for 3 seconds,
voice prompt"Please enter password"



- Phone CMS Enable
- CMS Phone No. 1
- CMS Phone No. 2
- CMS user Number
- CMS Dialing Times
- Internet CMS Enable
- Sever IP
- Sever Port
- Sever Account
- Sever Password
- Sever Heartbeat

6.4.1 Phone CMS Enable(the default is enabled)

For example: make phone alarm platform disabled

Press[*]for 3 seconds

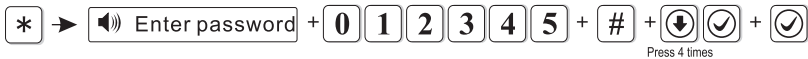

0 is disabled,1 is enabled, after the setting is completed, the screen will automatically return to the upper interface

6.4.2 CMS Phone No. 1

When alarm is triggered, the panel will dial CMS telephone number to inform central monitor server, CMS telephone number max.17 digits.

For example: Set CMS telephone number as 80012345

Press[*]for 3 seconds

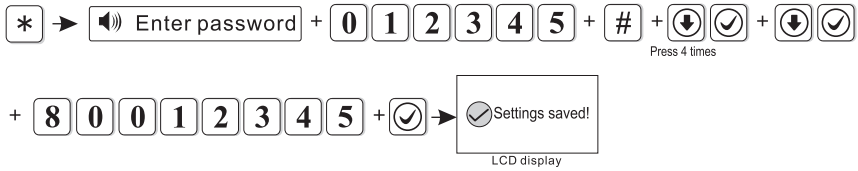

After the setting is completed, the screen will automatically return to the upper interface

6.4.3 CMS Phone No. 2

Please refer to 6.3.2

6.4.4 CMS user Number

The user No. is the identity code of the user at the alarm center.

For example: set user No. as 1701

Press[*]for 3 seconds

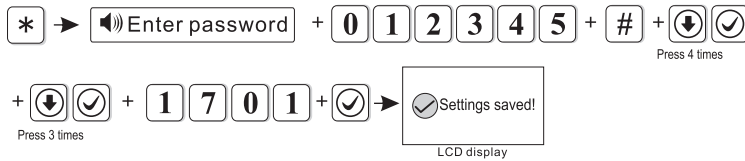

After the setting is completed, the screen will automatically return to the upper interface.

6.4.5 CMS Dialing Times

When alarm happens, the device will dial the CMS telephone no.1 and no.2 the factory default is 5 times, if the call is still not answered after 5 times, it will stop to dial out . for example: set dial times as 8.

Press[*]for 3 seconds

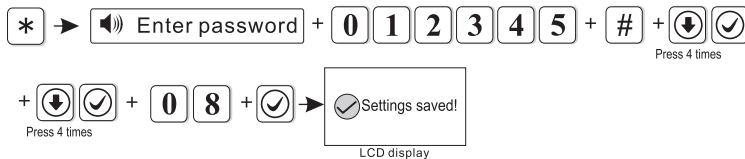

Dial times can be set as 1-15, high perch fill 0 when less than 2 bits. After the setting is completed, the screen will automatically return to the upper interface.

6.4.6 Internet CMS Enable (the default is disabled)

For example: Enable network platform.

Press[*]for 3 seconds



0 is disabled, 1 is enabled, after the setting is completed, the screen will automatically return to the upper interface.

6.4.7 Server IP

For example: set server IP as 192.168.1.66

Press[*]for 3 seconds

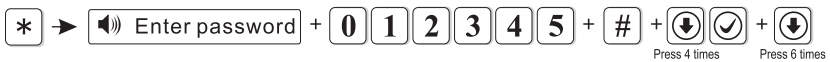

After the setting is completed, the screen will automatically return to the upper interface.

6.4.8 Server Port

For example: set server port as 5679 (default is 7974)

Press[*]for 3 seconds



After the setting is completed, the screen will automatically return to the upper interface.

6.4.9 Server Account

For example: set server register ID as 02001010.

Press[*]for 3 seconds

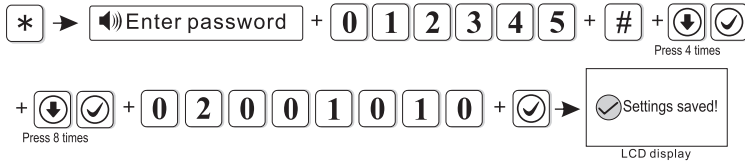

Register ID can be set up to 8 digits at most,
After the setting is completed, the screen
will automatically return to the upper interface.

6.4.10 Server Password

For example: set server register password as 12345678

Press[*]for 3 seconds

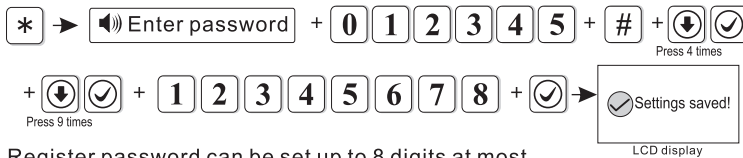

Register password can be set up to 8 digits at most,
After the setting is completed, the screen
will automatically return to the upper interface.

6.4.11 Server Heartbeat

Heartbeat time means the time interval that the device sending info to platform. every interval heartbeat time, the device will send heartbeat info to the platform. if the platform can not receive several heartbeat info, this device will be considered as offline, and record this offline in the platform data.

For example: set heartbeat time as 40s(heartbeat time is 1-255s,default is 25s)

Press[*]for 3 seconds

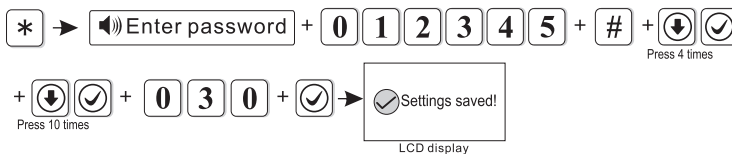

Heartbeat time can be set from 1-255, high perch fill 0 when less than 3 bits
After the setting is completed, the screen
will automatically return to the upper interface.

6.5 Set Voice Phone

Press[*]for 3 seconds, voice prompt"please enter password"

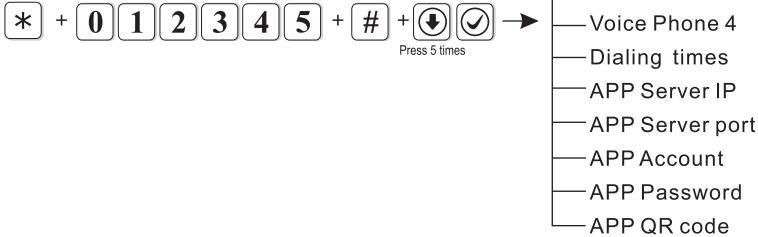

6.5.1 Set voice phone number

When alarm happens, the device will dial user's phone no., it can set 4 voice phone no. each phone number can be set up to 17 digits at most. For example: set voice phone 3 as 12345678

Press[*]for 3 seconds

[*] → [Speaker] Enter password + [0][1][2][3][4][5] + [#] + [Down Arrow][Checkmark] (Press 5 times)

+ [Down Arrow][Checkmark] (Press 2 times) + [1][2][3][4][5][6][7][8] + [Checkmark] → [Settings saved!] (LCD display)

Press [*] can delete the last digit, After the setting is completed, the screen will automatically return to the upper interface.

6.5.2 Dialing times

Default is 5 times.

For example: set voice phone dial times as 6.

Press[*]for 3 seconds

[*] → [Speaker] Enter password + [0][1][2][3][4][5] + [#] + [Down Arrow][Checkmark] (Press 5 times)

+ [Down Arrow][Checkmark] (Press 4 times) + [0][6] + [Checkmark] → [Settings saved!] (LCD display)

The dial times can be set as 1-15, high perch fill 0 when less than 2 bits. After the setting is completed, the screen will automatically return to the upper interface.

6.5.3 APP Server IP

①Set App server: default is 119.147.144.090

For example: set App server IP as 114.184.162.081

Press[*]for 3 seconds

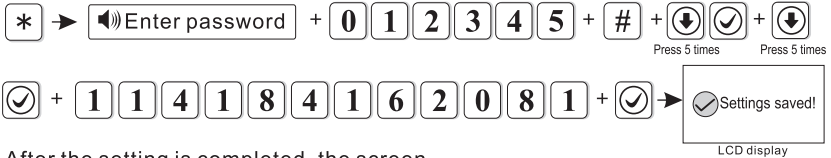

After the setting is completed, the screen will automatically return to the upper interface.

②APP Server Port: default is 18034

③APP Account: same as panel's ID, for example1AB7113E.

④APP Password: Network forwarding platform APP login password, default is 12345678, user can change it, can enter 16 digits.

⑤APP QR code: Scan QR code to add login account.

6.6 System options

Press[*]for 3 seconds, voice prompt "please enter password"

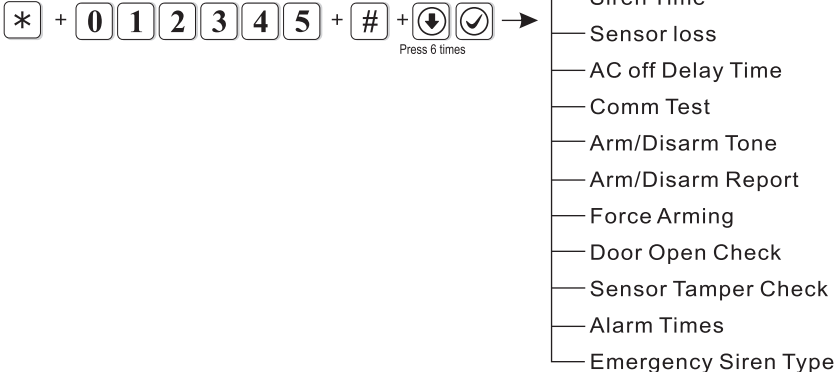

6.6.1 Entry Delay

When trigger delay zone, the panel will delay to alarm(default is 10s)

For example: set entry delay time as 20s

Press[*]for 3 seconds

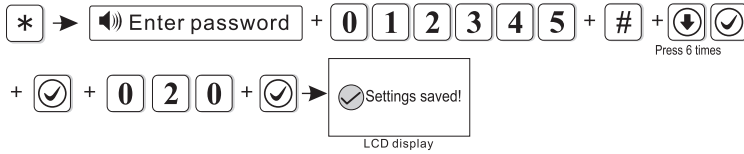

The entry delay time can be set from 1-255, high perch fill 0 when less than 3 bits. After the setting is completed, the screen will automatically return to the upper interface.

Note: the entry delay is only valid for the delay zone, other types of zone without delay.

6.6.2 Exit Delay

After user arming the system, the user has enough time to exit the protection area. (exit delay time is 1-255s, default is 10s)

For example: set exit delay time as 20s.

Press[*]for 3 seconds

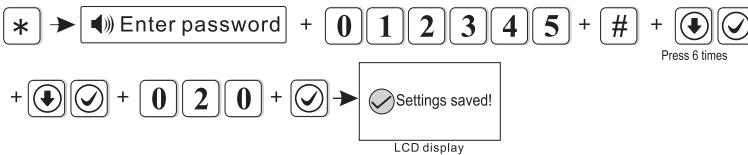

The entry delay time can be set from 1-255, high perch fill 0 when less than 3 bits. After the setting is completed, the screen will automatically return to the upper interface.

6.6.3 Siren Time

Siren time is 1-30 minutes, the default is 5 minutes.

For example: set siren time as 10 minutes.

Press[*]for 3 seconds

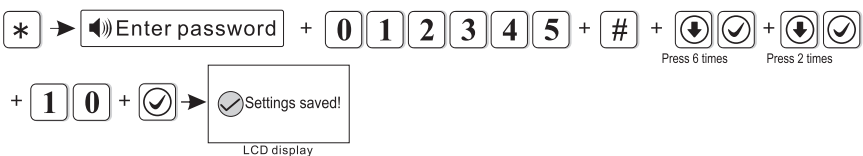

The siren time can be set from 1-30, high perch fill 0 when less than 2 bits. After the setting is completed, the screen will automatically return to the upper interface.

6.6.4 Sensor loss

In the set time period, the panel will detect if receive the status report or alarm info from the detector, if not receive, this detector will be regarded as loss, recommended loss inspection time not less than 6 hours.
(default is 0, disabled)

For example: set detector loss inspection time as 8 hours.

Press[*]for 3 seconds

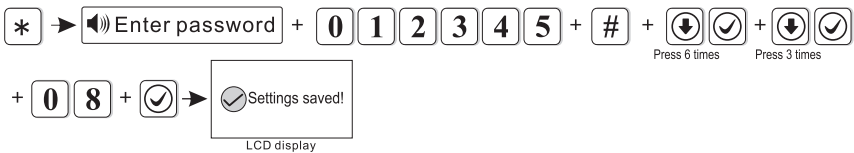

The detector loss inspection time can be set from 0-99, high perch fill 0 when less than 2 bits. after the setting is completed, the screen will automatically return to the upper interface

6.6.5 AC off Delay time

It means the time when AC off, the device will delay to report to CMS.
(0-99 minutes, default is 30 minutes)

For example: set AC off inspection time as 15 minutes.

Press[*]for 3 seconds

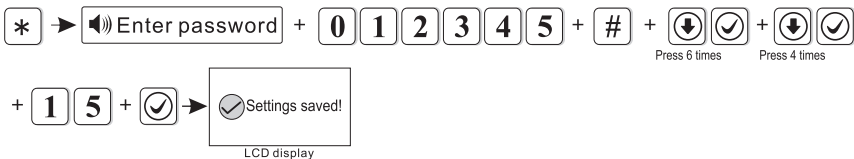

The AC off inspection time can be set from 0-99, high perch fill 0 when less than 2 bits. after the setting is completed, the screen will automatically return to the upper interface

- Note:**
1. this function mainly use for the area with unstable power
 2. when AC recovery in delay time, it will not send report to CMS.

6.6.6 Comm Test

Within this period, the alarm panel will send a test signal to the CMS to check if communication is working. (Factory default is 0, disable)

E.g. Set communication test period as 3h.

Press[*]for 3 seconds

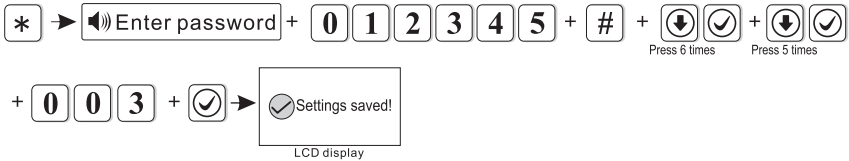

The communication test interval time can be set from 0-999, high perch fill 0 when less than 3 bits. after the setting is completed, the screen will automatically return to the upper interface

6.6.7 Arm/Disarm Tone

When user arm/disarm through remote controller, if siren will sound or not for prompting.(default is disabled)

For example: set arm/disarm tone is enabled.

Press[*]for 3 seconds

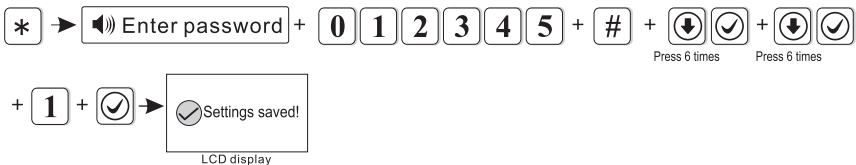

0 is disabled, 1 is enabled, after the setting is completed, the screen will automatically return to the upper interface.

6.6.8 Arm/Disarm Report

If enable to set force arm, when there is zone trouble, the system can be armed and report the trouble zone s bypass message to CMS. If disable the force arm, the system can not be armed(factory default is disable force arm)

Example: enable force arm.

Press[*]for 3 seconds

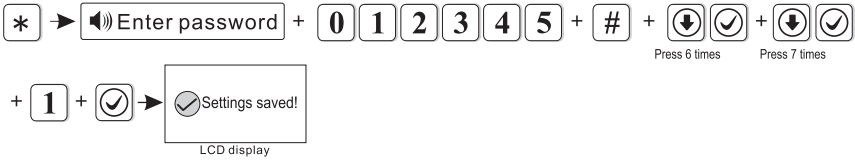

0 is disable, 1 is enable. After the setting is completed, the screen will automatically return to the upper interface.

6.6.9 Force Arming

if enable to set force arm, when there is zone trouble, the system can be armed and report the trouble zone s bypass message to CMS. If disable the force arm, the system can not be armed(factory default is disable force arm)
Example: enable force arm.

Press[*]for 3 seconds

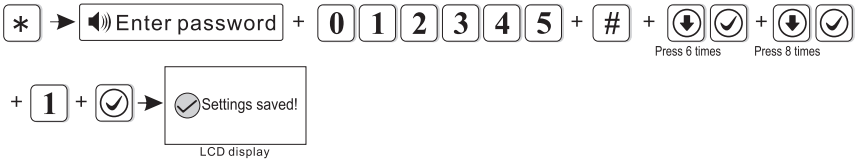

0 is disable, 1 is enable. After the setting is completed, the screen will automatically return to the upper interface.

6.6.10 Door Open Check

Set if the alarm panel show zone trouble on LCD screen or not when separate the magnetic strip from transmitter. (Factory default disable the inspection)
Example: enable the magnetic contact inspection

Press[*]for 3 seconds

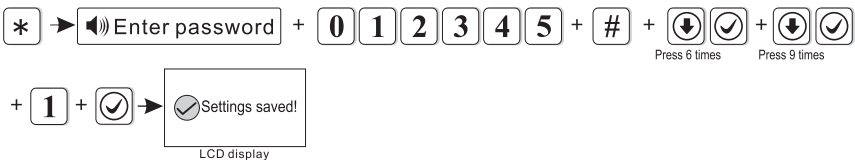

0 is disable, 1 is enable. After the setting is completed, the screen will automatically return to the upper interface.

6.6.11 Sensor Tamper Check

If the enable the checking when trigger the detector s tamper , will trigger alarm. If disable the checking, it will not trigger alarm.(factory default enable the checking)Example: disable the checking of wireless detector tamper.

Press[*]for 3 seconds



0 is disable, 1 is enable. After the setting is completed, the screen will automatically return to the upper interface.

6.6.12 Alarm Times

If set the alarm alarm times as 3, when zone start alarm but the zone is trigger 3 times again, the panel will not make alarm.(factory default is disabled)

E.g. set zone alarm times as 3 time

Press[*]for 3 seconds



* switch selection,After the setting is completed, the screen will automatically return to the upper interface.

6.6.13 Emergency Siren Type(the default setting is mute)

For example: set emergency alarm siren type is pedal point.

Press[*]for 3 seconds



* switch selection, After the setting is completed, the screen will automatically return to the upper interface.

6.7 Wireless

Press * for 3 seconds, voice prompting “enter password”.



- Wireless Remote
- Wireless Sensor
- Wireless Switch
- Wireless Siren
- Wireless doorbell

6.7.1 Wireless Remote

Press[*]for 3 seconds

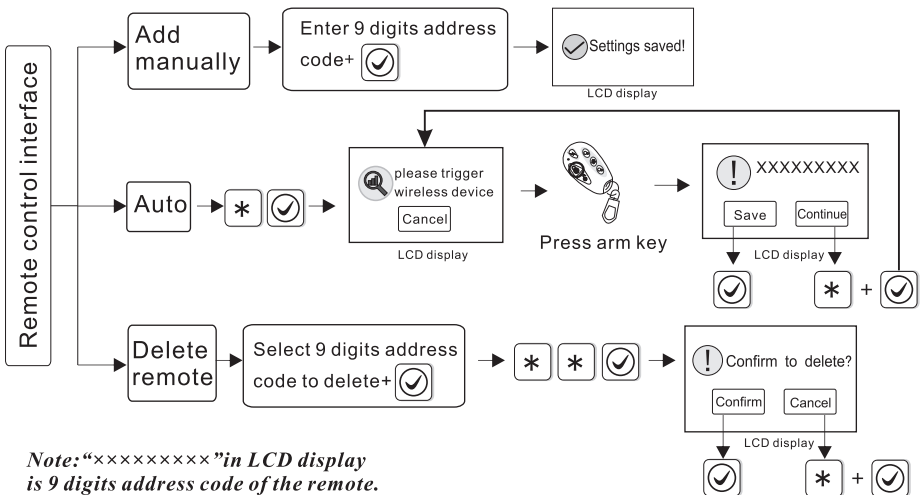

Note: “XXXXXXXXXX” in LCD display is 9 digits address code of the remote.

Support 8 remote control at max.

E.g: Add address code (112005123) of the remote automatically.

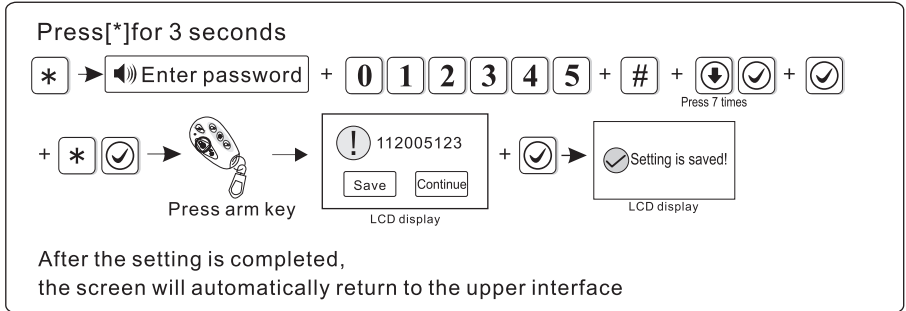

6.7.2 Wireless Sensor

Press[*]for 3 seconds

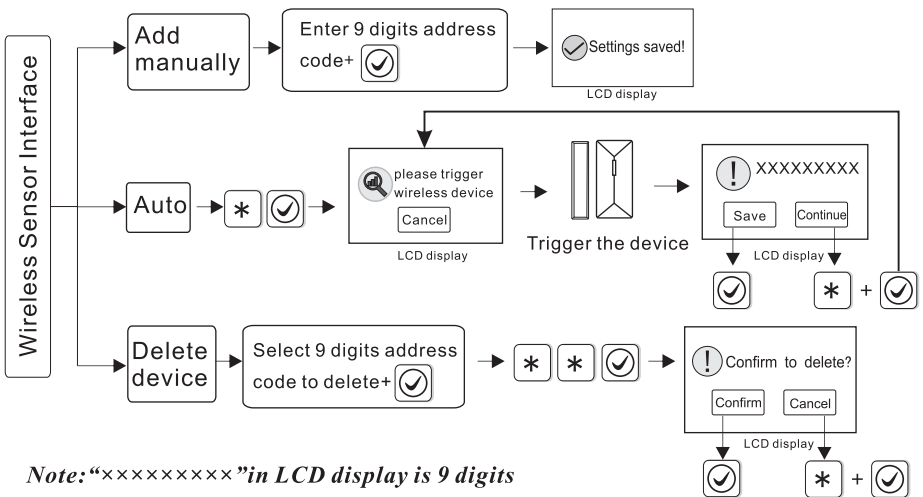

Support 32 wireless detectors at max, the zone number will be the order of detectors added.

E.g.: Delete the address code (118006123) of the detectors

Press[*]for 3 seconds

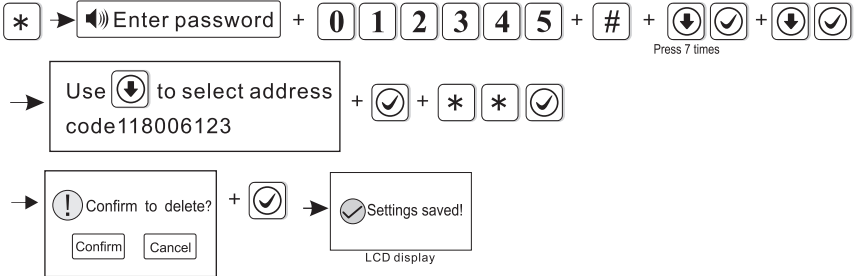

After the setting is completed, the screen will automatically return to the upper interface

6.7.3 Wireless Switch

Press[*]for 3 seconds

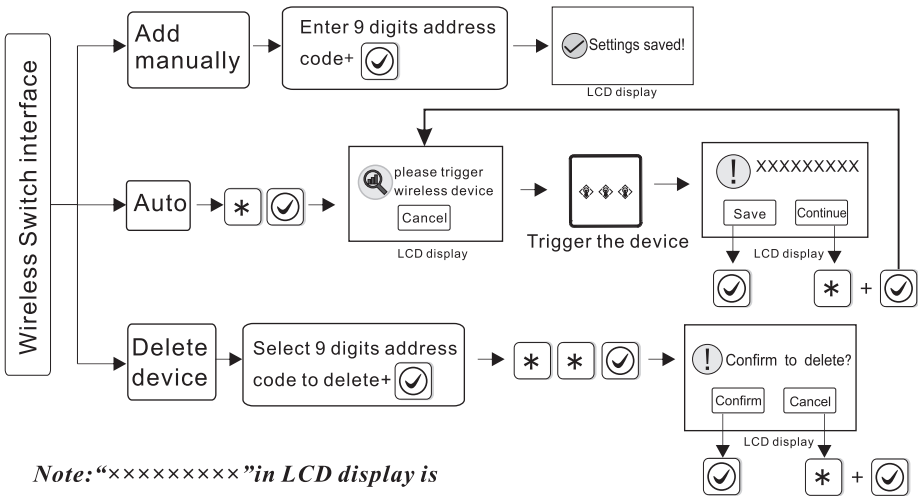

Note:“XXXXXXXX”in LCD display is 9 digits address code of the wireless electrical switch.

Support 16channel Wireless Electrical Switch at max.
E.g.: Add address code (100112123) of electrical switch manually.

Press[*]for 3 seconds

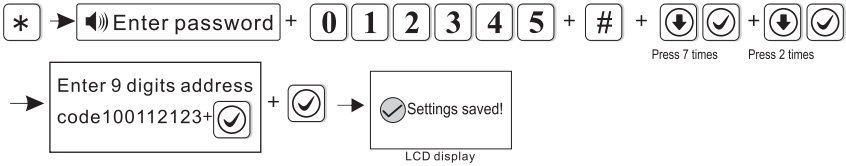

After the setting is completed, the screen will automatically return to the upper interface

6.7.4 Wireless Siren

Support one dual-way siren, countless one-way siren.

Press[*]for 3 seconds

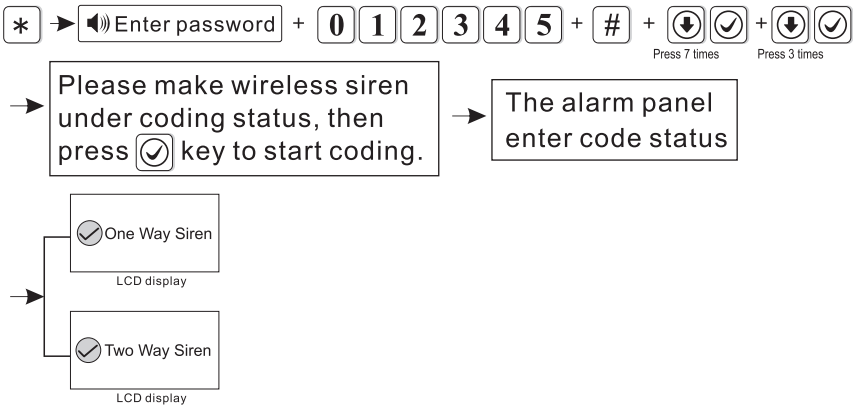

If it is a two-way wireless alarm, the screen will display its address code. After the setting is completed, the screen will automatically return to the upper interface

Note: When tamper alarm from the dual-way siren, the alarm panel will show zone 41 alarm. Only one dual-way wireless siren can be added, but no limits for one way wireless siren. If need to add both dual way and one way siren, please add dual way siren at last.

6.7.5 Wireless doorbell

Press[*]for 3 seconds

+ + + +

After that, the following operations can be carried out:

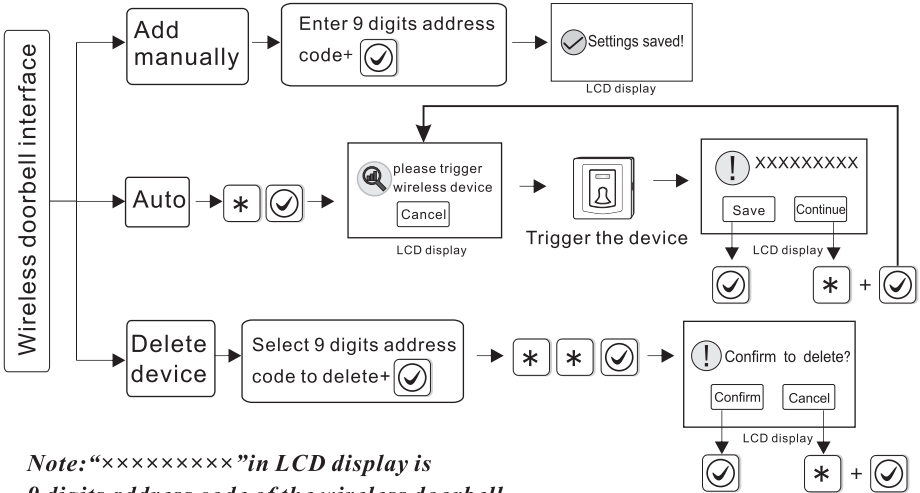

Note: "XXXXXXXX" in LCD display is 9 digits address code of the wireless doorbell.

E.g. Add address code (112102118) of doorbell.

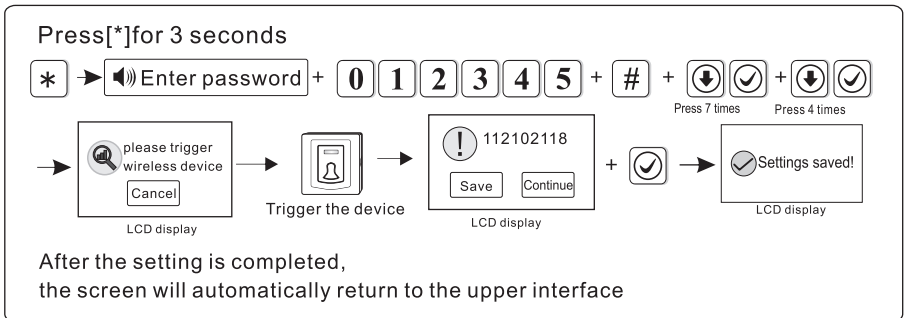

6.8 Zone Management

Press * for 3 seconds, voice prompting “enter password”.

* + 0 1 2 3 4 5 + # +   can set zone type
Press 8 times

Zone 1-32 is for wireless device, Zone 32-40 is for wired device. User can set zone type, zone alarm siren type and chime function.

*Instruction: * is downward selection, # is open option from LCD screen operations.*

① Zone Type

The type of zone attribution is as below

>disable zone > delay zone > perimeter zone
 >interior zone >emergency zone > 24 hours zone
 >fire zone > key zone(only for zone 33-40)

A.Zone attribution is the alarm type of the zone display on the alarm panel’s LCD screen when the zone is triggered. When set the zone attribution as 0 is to disable the zone. The alarm panel will not make alarm when trigger this zone.

B.interior zone only trigger alarm when the zone is triggered in armed status.

C.delay and perimeter zone trigger alarm when the zone is triggered in armed or home arm status.

D.emergency zone, 24 hours zone, fire zone will trigger alarm when system are in any status.

E.wireless zone can not set key zone type. When wired zone is set as key zone, trigger the zone, system turn to disarm status. The zone restore, system turn to armed status. This is available to access control system.

F.Key zone is used only for wired zone(33-40 zone)

② set zone siren type

User can set three type: Continuous, pulse, Mute (factory default is Continuous)

③ Chime Function

When the detector as delay zone, once it is triggered, the alarm panel will sound “dingdong” or “welcome”, optional. Factory default is disabled.

Factory default:

Zone	Zone Type	Siren type	Chime
1~2	Delay	Continuous	Disabled
3~32	Burglar	Continuous	Disabled
33~40	Disabled	Continuous	Disabled

E.g.: set zone 39 as key zone

Press[*]for 3 seconds

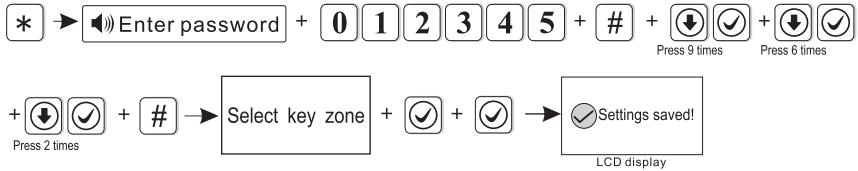

Press [*] mobile, according to [#] open selection, After the setting is completed, the screen will automatically return to the upper interface.

6.9 Set Alarm Alert

Press * for 3 seconds, voice prompting “enter password”.



Press [#] to select alarm type, press [#] again to enable/disable alert path.

:enable :disable

Note: This machine does not support the mail function.

Factory default:

Alarm Alert Type	Factory Default			
	CMS	Voice Phone	SMS	Email
Delay	<input checked="" type="checkbox"/>	<input checked="" type="checkbox"/>	<input checked="" type="checkbox"/>	<input type="checkbox"/>
Perimeter	<input checked="" type="checkbox"/>	<input checked="" type="checkbox"/>	<input checked="" type="checkbox"/>	<input type="checkbox"/>
Interior	<input checked="" type="checkbox"/>	<input checked="" type="checkbox"/>	<input checked="" type="checkbox"/>	<input type="checkbox"/>
Emergency	<input checked="" type="checkbox"/>	<input checked="" type="checkbox"/>	<input checked="" type="checkbox"/>	<input type="checkbox"/>
24 Hour	<input checked="" type="checkbox"/>	<input checked="" type="checkbox"/>	<input checked="" type="checkbox"/>	<input type="checkbox"/>
Fire	<input checked="" type="checkbox"/>	<input checked="" type="checkbox"/>	<input checked="" type="checkbox"/>	<input type="checkbox"/>
Panic	<input checked="" type="checkbox"/>	<input checked="" type="checkbox"/>	<input checked="" type="checkbox"/>	<input type="checkbox"/>
Tamper	<input checked="" type="checkbox"/>	<input checked="" type="checkbox"/>	<input checked="" type="checkbox"/>	<input type="checkbox"/>

Alarm Alert Type	Factory Default			
	CMS	Voice Phone	SMS	Email
System Away	<input checked="" type="checkbox"/>	<input type="checkbox"/>	<input checked="" type="checkbox"/>	<input type="checkbox"/>
System Disarm	<input checked="" type="checkbox"/>	<input type="checkbox"/>	<input checked="" type="checkbox"/>	<input type="checkbox"/>
System Stay	<input checked="" type="checkbox"/>	<input type="checkbox"/>	<input checked="" type="checkbox"/>	<input type="checkbox"/>
System low battery	<input checked="" type="checkbox"/>	<input type="checkbox"/>	<input checked="" type="checkbox"/>	<input type="checkbox"/>
AC loss	<input checked="" type="checkbox"/>	<input type="checkbox"/>	<input checked="" type="checkbox"/>	<input type="checkbox"/>
AC Restore	<input checked="" type="checkbox"/>	<input type="checkbox"/>	<input checked="" type="checkbox"/>	<input type="checkbox"/>
Alarm Cancel	<input checked="" type="checkbox"/>	<input type="checkbox"/>	<input checked="" type="checkbox"/>	<input type="checkbox"/>
Sensor Low Battery	<input checked="" type="checkbox"/>	<input type="checkbox"/>	<input type="checkbox"/>	<input checked="" type="checkbox"/>
Sensor bat Recovery	<input checked="" type="checkbox"/>	<input type="checkbox"/>	<input type="checkbox"/>	<input checked="" type="checkbox"/>
RF lost	<input checked="" type="checkbox"/>	<input type="checkbox"/>	<input type="checkbox"/>	<input checked="" type="checkbox"/>
Programming Changed	<input checked="" type="checkbox"/>	<input type="checkbox"/>	<input type="checkbox"/>	<input checked="" type="checkbox"/>
Arm Failed	<input checked="" type="checkbox"/>	<input type="checkbox"/>	<input type="checkbox"/>	<input checked="" type="checkbox"/>
Periodic Test Report	<input checked="" type="checkbox"/>	<input type="checkbox"/>	<input type="checkbox"/>	<input checked="" type="checkbox"/>
Zone Bypass	<input checked="" type="checkbox"/>	<input type="checkbox"/>	<input type="checkbox"/>	<input checked="" type="checkbox"/>
System Bat Restore	<input type="checkbox"/>	<input type="checkbox"/>	<input type="checkbox"/>	<input checked="" type="checkbox"/>
Communication Trouble	<input type="checkbox"/>	<input type="checkbox"/>	<input type="checkbox"/>	<input checked="" type="checkbox"/>
Zone Bypass Cancel	<input type="checkbox"/>	<input type="checkbox"/>	<input type="checkbox"/>	<input checked="" type="checkbox"/>
Communication Restore	<input type="checkbox"/>	<input type="checkbox"/>	<input type="checkbox"/>	<input checked="" type="checkbox"/>
Loop Open/Short	<input type="checkbox"/>	<input type="checkbox"/>	<input type="checkbox"/>	<input type="checkbox"/>
Loop Restore	<input type="checkbox"/>	<input type="checkbox"/>	<input type="checkbox"/>	<input type="checkbox"/>
Bell Troubl	<input type="checkbox"/>	<input type="checkbox"/>	<input type="checkbox"/>	<input type="checkbox"/>
Bell Restore	<input type="checkbox"/>	<input type="checkbox"/>	<input type="checkbox"/>	<input type="checkbox"/>
Duress	<input checked="" type="checkbox"/>	<input type="checkbox"/>	<input checked="" type="checkbox"/>	<input type="checkbox"/>
Entry/Exit Recovery	<input type="checkbox"/>	<input type="checkbox"/>	<input type="checkbox"/>	<input type="checkbox"/>
Perimeter Recovery	<input type="checkbox"/>	<input type="checkbox"/>	<input type="checkbox"/>	<input type="checkbox"/>

Alarm Alert Type	Factory Default			
	CMS	Voice Phone	SMS	Email
Burglary Recovery	<input type="checkbox"/>	<input type="checkbox"/>	<input type="checkbox"/>	<input type="checkbox"/>
Panic Recovery	<input type="checkbox"/>	<input type="checkbox"/>	<input type="checkbox"/>	<input type="checkbox"/>
24 Hour Recovery	<input type="checkbox"/>	<input type="checkbox"/>	<input type="checkbox"/>	<input type="checkbox"/>
Fire Recovery	<input type="checkbox"/>	<input type="checkbox"/>	<input type="checkbox"/>	<input type="checkbox"/>
Emergency Recovery	<input type="checkbox"/>	<input type="checkbox"/>	<input type="checkbox"/>	<input type="checkbox"/>
Tamper Recovery	<input type="checkbox"/>	<input type="checkbox"/>	<input type="checkbox"/>	<input type="checkbox"/>
RF Loss Recovery	<input type="checkbox"/>	<input type="checkbox"/>	<input type="checkbox"/>	<input type="checkbox"/>

Duress password: **1** + **1** **2** **3** **4** + 
user password



When you enter the duress password, you will trigger an duress alarm. If enter duress password When the system is under arm status, keypad will display system is disarmed, stop siren but send alarm info and alarm call.
 (pls set the CMS phone # and follow me phone #)

Example, A arm the system, B enter the area and trigger alarm, B threaten A disarm the system. A enter the duress password. The alarm panel will show disarm status but will send alarm info can call.

For example: Set perimeter alarm to open all sending paths.
 (Perimeter alarm default only to close the mail)

Press[*]for 3 seconds

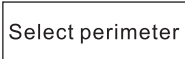
 →  Enter password + **0** **1** **2** **3** **4** **5** + **#** +   + **#**
Press 9 times

→  +  +  + **#** +  → 
Press 4 times LCD display

Press ***** to move the selection, press **#** to enable/disable the selection, After setting, the screen will automatically return to the previous interface.

6.10 SmartHome

Press * for 3 seconds, voice prompting “enter password”.

***** + **0** **1** **2** **3** **4** **5** + **#** +   Press 10 times Set the timing to open or close the wireless switch.

If you want to manually turn the wireless switch on or off, press and hold ***** for 3 seconds when there is no operation on the panel until the panel voice prompt "Enter password", pls enter the user password **1 2 3 4** to turn on / off the wireless switch.

For example: Set the wireless switch to turn on at 18:35 and turn off at 22:45. (00:00 is invalid time)

Press ***** for 3 seconds

***** → Enter password + **0 1 2 3 4 5** + **#** + + Press 10 times

1 8 3 5 + ***** + **2 2 4 5** + → LCD display

Press ***** to go to the next column, the screen automatically return to the previous interface after setting.

6.11 Time

Press * for 3 seconds, voice prompting "enter password".

***** + **0 1 2 3 4 5** + **#** + Press 11 times

- Auto time
- Daylight-saving time
- 24-hour system
- Time zone
- Time
- Timing Arm/Disarm 1
- Timing Arm/Disarm 2
- Timing Arm/Disarm 3
- Timing Arm/Disarm 4

6.11.1 Auto time (default is open)

For example: Set automatic timing to close

Press ***** for 3 seconds

***** → Enter password + **0 1 2 3 4 5** + **#** + + Press 11 times

+ **0** + → LCD display

0 is disable, 1 is enable. After the setting is completed, the screen will automatically return to the upper interface.

6.11.2 Daylight-saving time(The default is to shut down)

Summer Time is set aside by an hour at 2 Am on the first Sunday of middle April. Change 2Am to 3 Am. At 2 o'clock in the morning on the first Sunday in mid-September, The hour will be set aside for one hour, that is, changed from 2 Am to 1Am, and the summer time ends.

For example: Set Summer Time active.

Press[*]for 3 seconds

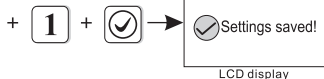

0 is disable, 1 is enable. After the setting is completed, the screen will automatically return to the upper interface.

6.11.3 24-hour system(The default is to open)

Example: Set time-zone as London time-zone GMT

Press[*]for 3 seconds

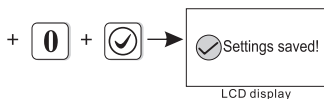

0 is disable, 1 is enable. After the setting is completed, the screen will automatically return to the upper interface.

6.11. 4 Time zone(default set is Beijing time GMT+8:00)

Example: Set time-zone as London time-zone GMT

Press[*]for 3 seconds

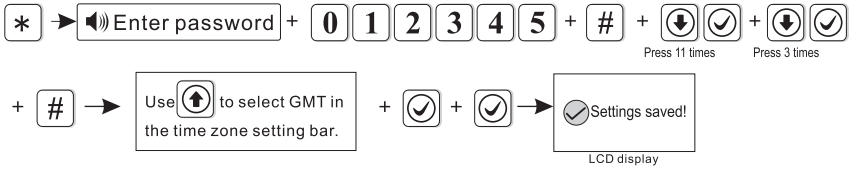

After the setting is completed, the screen will automatically return to the upper interface.

6.11.5 Time

Example Set the time to 15:30 05 on 1 Dec, 2018 .

Press[*]for 3 seconds

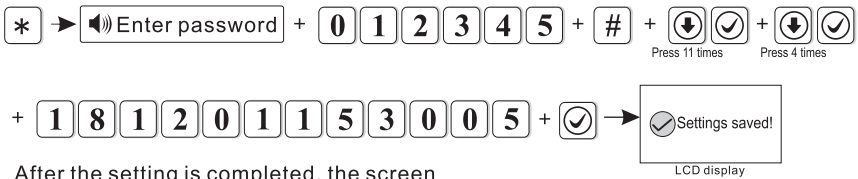

After the setting is completed, the screen will automatically return to the upper interface.

Note: If you turn on automatic calibration, this setting is invalid.

6.11.6 Timing Arm/Disarm

You can set 4 pairs time for auto timing arm/disarm. Example: set the NO.1 pair as auto arm at 7:58, disarm at 24:03

Press[*]for 3 seconds

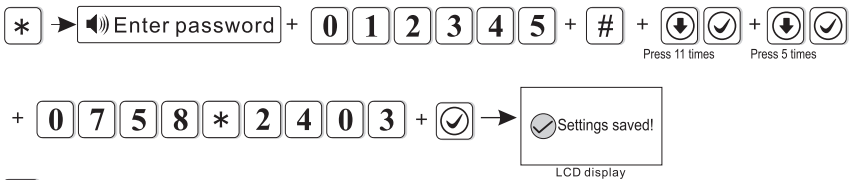

* For downward selection, After the setting is completed, the screen will automatically return to the upper interface.

6. 12 Restart

Press * for 3 seconds, voice prompting “enter password”.

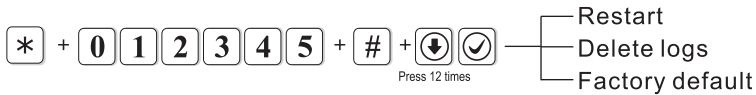

6.12. 1 Restart

For example: restart the system.

Press[*]for 3 seconds

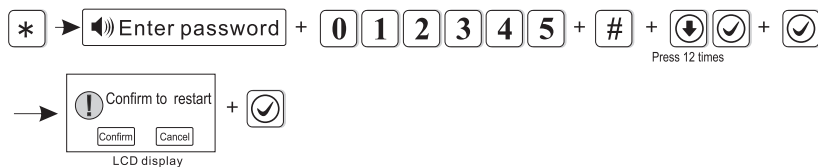

The alarm host will restart after setting.

6.12. 2 Delete logs

Press[*]for 3 seconds

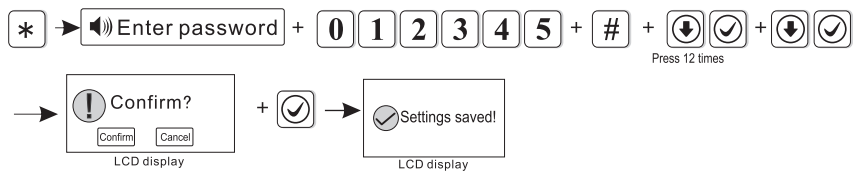

After the setting is completed, the screen will automatically return to the upper interface.

6.12.3 Factory default

Press[*]for 3 seconds



 Press 12 times Press 2 times

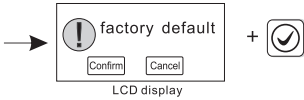

 LCD display

After the setting is completed, the screen will automatically return to the upper interface.

Note: After Restore to factory default, the host will clear all the parameter settings, all detectors, remote control, etc. Please Re-code accessories to the alarm panel and re-set other parameters, otherwise it will not work properly.

6.13 Display



 Press 13 times

— Operating brightness
 — Standby brightness

Press  to Increase the brightness

Press  to Reduce the brightness

6.14 RFID

Press * for 3 seconds, voice prompting “enter password”.



 Press 14 times

to enter RFID setting.

Example: Add the RFID and set it with disarm function.

Press[*]for 3 seconds



→ Keep the RFID tag near the sensor area + [*][#] →

- Options:
- Disarm
 - Home
 - Disarm SMS
 - Home SMS
 - Disarm-call phone 1

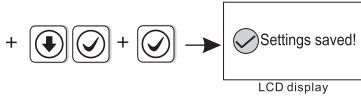

After the setting is completed, the screen will automatically return to the upper interface.

Note: 1. Pls preset the message text on WEB MENU for the two options [disarm and send sms][home arm and send sms]

2. You can choose to manual enter the RFID card # to add the RFID card.

6.15 Others

Press * for 3 seconds, voice prompting “enter password”.



6.15.1 Recording

20seconds time to record alarm message. This alarm message will be hear when you take the alarm phone call from the alarm panel.

Press[*]for 3 seconds



+ [#] → Start record after hear beep sound. The alarm message will play once after finish recording.

6.15.2 Play

Press[*]for 3 seconds

* → Enter password + 0 1 2 3 4 5 + # + +

Press 15 times

+ → play the alarm message

6.15.3 PGM

the voltage will change from 0V to 14.5V as soon as some events occurs.
 (Default is follow alarm output)

Trigger events can be set as below

- | | |
|--------------------------------------|---------------------------------|
| 1. Follow alarm output | 2. Follow AC power fault output |
| 3. Follow arm output | 4. Follow disarm output |
| 5. Follow communication fault output | 6. Password control output |

Example : set PGM output follow AC power fault output.

Press[*]for 3 seconds

* → Enter password + 0 1 2 3 4 5 + # + +

Press 15 times Press 2 times

+ + + →

LCD display

Hint: when setting as password control output, press key 5 for 3 seconds, then enter the user password, the programme output port will be open or closed. Voice phone or SMS also can open or close the outport.

6.15.4 Chime Music

Two tones optional : "ringing tone" and "Welcome". (Default welcome)
 For example: set the door open tone as "ringing tone"

Press[*]for 3 seconds

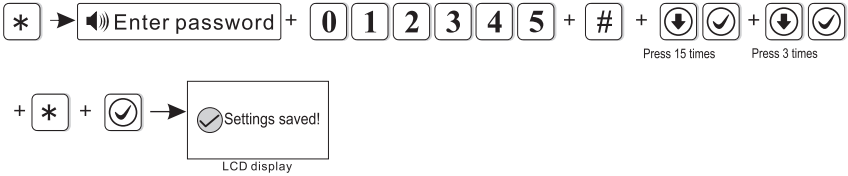

After the setting is completed, the screen will automatically return to the upper interface.

6.16 Corss zone

Press * for 3 seconds, voice prompting “enter password”.



Trigger zone 1 or zone 2 only will not trigger alarm. During related time trigger zone 1 and zone 2, then the alarm will be trigger.

Example: Set zone 5 and zone 9 as pair # 4 related zone, related time is 120secs.

Press[*]for 3 seconds

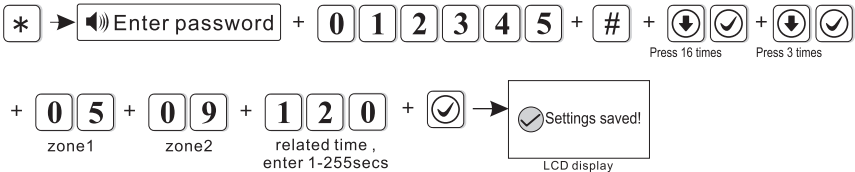

After the setting is completed, the screen will automatically return to the upper interface.

NOTE: Can set 8 pairs related zone.

6.17 About

Press * for 3 seconds, voice prompting “enter password”.



Chapter VII Technical Specification

General information

- 1.Power supply: 15V/2000mA
- 2.Built in rechargeable battery:11.1V/1000mAh
(It will have low battery indication when battery voltage lower than 9.6V)
- 3.Disabled working voltage:8.7V
- 4.System static current: <50mA(exclude wired detector)
- 5.System alarming current: <300mA(exclude wired high siren current)
- 6.System maximum output current: ≤100mA(supply wired detector)
- 7.Resistance can be triggered alarm within -40%to+40%.
- 8.Alarm is delay setting
- 9.Frequency:433MHz/868MHz(Optional)
- 10.Signal transmit distance: 100 to 150 meters (open area)
- 11.The method of alarming dial: Internet IP, GSM or GPRS
- 12.Communication protocol with CMS: Ademco Contact ID
- 13.DTMF dial frequency variation: < 1.5%
- 14.Recording time:20s

WiFi features

- Standard: 802.11 b/g/n
- Built-in Tensilica L106 ultra-low-power 32-bit micro MCU supporting RTOS
- Built-in TCP/IP protocol stack
- WiFi @ 2.4GHz, Supports WPA/WPA2 Security Mode
- Support AT remote upgrade and cloud OTA upgrade
- Support STA/AP/STA+AP working mode
- Supports Smart Config features (including Android and iOS devices)

Physical performance.

- Operation temperature range: 0°C-45°C(32°F-120°F)
- Storage temperature range: -20°C-60°C(-4°F-140°F)
- Relative humidity: 85% at 30°C(86°F)
- Color: See real

Chapter VIII Maintenance

10.1 Regular Test

Design of components of the system is to reduce maintenance cost, but still it is suggested that periodical check may be carried out.

10.2 The Cleanliness of Control Main Machine

Main control panel may be stained by fingers or covered by dust after using for a while. Use soft cotton cloth or sponge to clean it, don't use any lubricant, liquid such as kerosene, acetone and strong gel which will damage appearance and the transparency of top window.

Attention: don't use any lubricant, liquid such as kerosene, acetone and strong gel which will damage appearance and the top transparency of window.

Chapter IX Limitation of the Products

Although the products is a high standard products, there is also some limitation of them such as false alarm or no alarm. The reasons may be below:

Lack of maintenance, the system needs maintenance and test regularly test the sensitive of the detector may decrease and the siren may not whistle.

Lack of power supply if no power input and the back up power is not enough, the panel can not work normally.

Limitation of smoke detectors, if the smoke is far from the smoke detector, the detector could not alarm.

If the intrude break in through some door or window not monitored. Or someone know how to make the system not work.

