

PASSIVE INFRARED DETECTOR

**RX CORE** series  
**RXC-ST**

**Grade 2**  
EN50131-2-2

# DIGITAL QUAD ZONE LOGIC

Built on OPTEx's proven RX and CX series technology, RXC-ST provides higher performance in higher temperatures, features digital target recognition and is suitable for Grade 2 residential, commercial or industrial applications.



**QUAD ZONE LOGIC**  
Digital target recognition  
for small animal tolerance

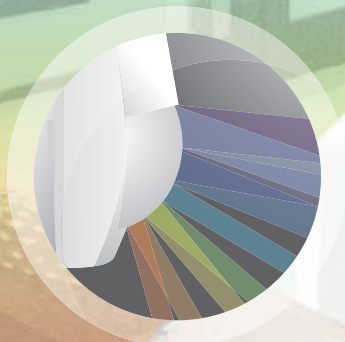

**HIGH DENSITY PATTERN**  
To enhance catch  
performance

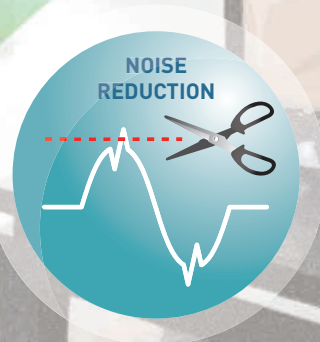

**NOISE REDUCTION**  
Improved RF and white  
light immunity

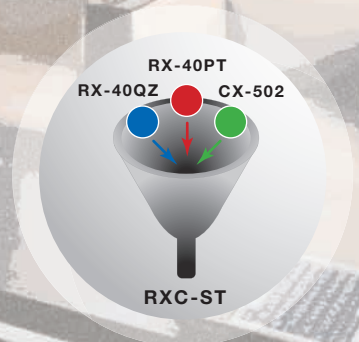

**PROVEN TECHNOLOGY**  
Built on three iconic  
detectors' technology

## PASSIVE INFRARED DETECTOR

# RX CORE Series

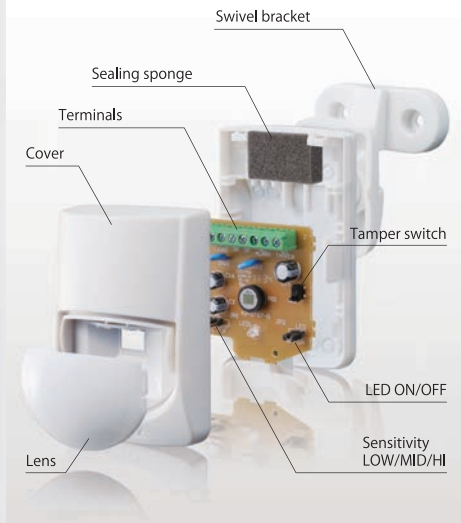

## DIGITAL QUAD ZONE LOGIC

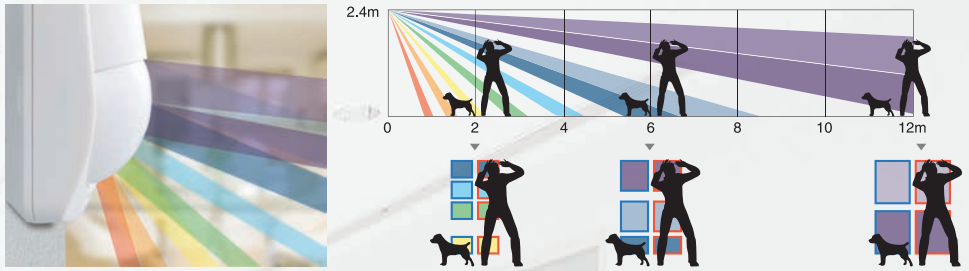

RX CORE has 78 dense zones to cover the whole coverage. At any spot within the coverage more than 4 (quad) zones are utilized to verify if it should generate alarm or not. Also The CORE Platform enabled the QUAD ZONE LOGIC to evolve to the next step. Providing digital quantification of infrared energy, RX-CORE enhanced accuracy in both human detectability and pet immunity.

## SILENT OUTPUT



The original micro-processor technology enabled ECO PLATFORM operate under complete silence. There is no mechanical relay component that disturb the environment with clicking noise and making RX-CORE invisible in daily scenes.

## MULTI ANGLE BRACKET

Ceiling and wall mounting are available. Horizontally  $\pm 45$  degree, Vertically 0 to 15 degree downwards.



Ceiling mount

Wall mount

## BASIC PERFORMANCE

### ADVANCED SEALED OPTICS



### ADVANCED TEMPERATURE COMPENSATION LOGIC

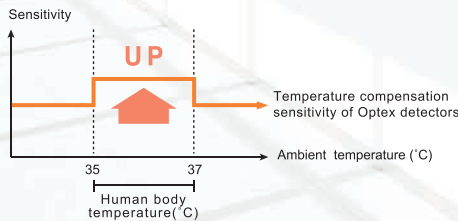

It automatically increases the detector's sensitivity under high temperature conditions, especially where the background temperature ranges from 35-37°C (63 - 67°F), close to that of the human body.

## OPTION

### 18m long range lens : FL-60N

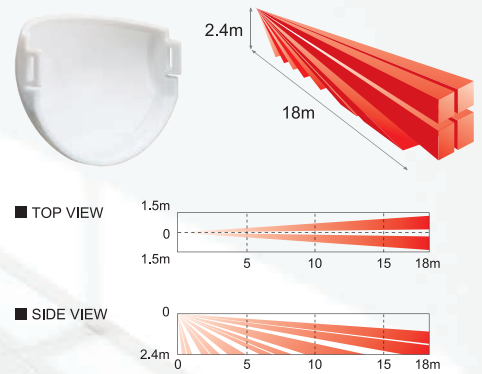

## COVERAGE

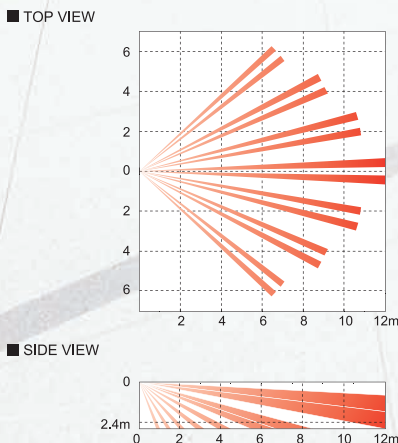

## SPECIFICATIONS

Model	RXC-ST
Detection method	Passive infrared
Coverage	12m x 12m(40ft x 40ft) 85°wide
Detection zones	78 zones
Mounting height	1.5 to 2.4m (5 to 8ft)
LED alarm indicator	Switchable ON/OFF
Alarm period	Approx. 2.5 sec
Alarm output	N.C., 24VDC 0.2A max.
Tamper switch	N.C., Open when cover is removed.
Sensitivity/range	Switchable LOW/MID/Hi
Warm up period	Approx. 30 sec
Power input	9.5 to 16VDC
Current draw	8mA(normal), 11mA(max.) at 12VDC
Dimensions	93.4mm x 61.4mm x 46.0mm <HxWxD>
Weight	Approx. 70g (with bracket: 90g)
Operating temperature	-20°C to +50°C(-4°F to +122°F)
Environmental humidity	95% max.
RF interference	No alarm 10V/m

## DIMENSIONS

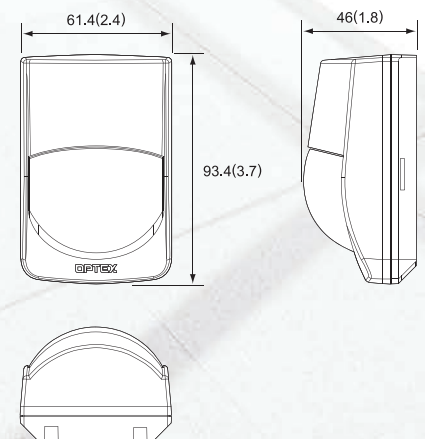

※Specifications are subject to change without prior notice.

Unit:mm(inch)



**OPTEX CO., LTD.** (ISO 9001 Certified / ISO14001 Certified)

5-8-12 Ogoto, Otsu, Shiga, 520-0101 Japan

TEL +81(0)77 579 8670 FAX +81(0)77 579 8190

<http://www.optex.co.jp/e/>

**OPTEX INCORPORATED (USA)**

<http://www.optexamerica.com/>

**OPTEX (EUROPE) LTD. (UK)**

<http://www.optex-europe.com/>  
(ISO9001 Certified)

**OPTEX SECURITY SAS (FRANCE)**

<http://www.optex-security.com/>

**OPTEX KOREA CO., LTD. (KOREA)**

<http://www.optexkorea.com/>

**OPTEX SECURITY Sp. z o.o. (POLAND)**

<http://www.optex.com.pl/>

**OPTEX (DONGGUAN) CO., LTD.**

<http://www.optexchina.com/>

**SHANGHAI OFFICE (CHINA)**