

# PABX

Group Telephone System



## MS Series User's Manual

Please read this manual before using

# Table of Contents

<b>Chap 1 Brief Introduction &amp; Features.....</b>	<b>1</b>
1.1 System Overview.....	1
1.2 Features.....	1
<b>Chap 2 Installation &amp; Connection.....</b>	<b>2</b>
2.1 System Appearance.....	2
2.2 Technical Parameter.....	4
2.3 Attention.....	4
2.4 Warning.....	5
2.5 Installation procedure.....	5
2.5.1 Connecting C.O. lines & extensions to the unit.....	5
2.5.2 Zero-load power-on inspection:.....	5
2.6 Direct Access when Power Failure.....	6
<b>Chap 3 System programming.....</b>	<b>7</b>
3.1 Before programming.....	7
3.2 Basic Command.....	7
3.2.1 Enter into System Programming Status.....	7
3.2.2 Change the Password.....	7
3.2.3 Flash Time Setting.....	8
3.2.4 System Restore Default Setting.....	8
3.2.5 Set Delay time for outgoing call transfer.....	8
3.3 Enable/Disable C.O. Lines.....	9
3.3.1 Enable All C.O. Lines.....	9
3.3.2 Disable All C.O. Lines.....	9
3.3.3 Enable No. M C.O. Line.....	9
3.3.4 Disable No.M C.O. Line.....	9
3.4 Day/night mode & weekend mode setting.....	9
3.4.1 System Date/Time setting (Optional for higher version MS+ series only).....	9
3.4.2 Day/night mode setting.....	10
3.4.3 Weekend mode setting (Optional for higher version MS+ series only).....	10
3.5 Set Operating mode.....	11
3.5.1 Set Auto-attendant work Mode (OGM) for All C.O. Lines.....	11
3.5.2 Set Operator work mode for all C.O. Lines.....	11
3.5.3 Set Auto-attendant Mode (OGM) for Certain C.O. line.....	11
3.5.4 Set Operator work mode for Certain C.O. line.....	11
3.5.5 Enable/Disable fast dialing in OGM mode.....	12
3.5.6 CRBT (Directly ring while play OGM Process in Auto-attendant Mode).....	12
3.6 OGM setting (Outgoing Message).....	12
3.6.1 Set OGM section mode.....	12
3.6.2 OGM recordable time.....	13
3.6.3 OGM Recording(multiple section mode).....	13
3.6.4 OGM playing(multiple section mode).....	14

3.6.5 One section OGM Mode.....	14
3.7 Review the Holding Music.....	14
3.8 Set Operator and Ringing Extension.....	14
3.8.1 Set Operator.....	14
3.8.2 Set Ringing Extensions in Day mode.....	15
3.8.3 Set Ringing Extension n Night mode.....	15
3.8.4 Set C.O.lines ringing mode.....	16
3.8.5 Ringing mode when all the ringing extensions is busy.....	16
3.9 C.O.Line Call Process in Auto-attendant Mode.....	16
3.9.1 OGM busy Process in Auto-attendant work Mode.....	16
3.9.2 No dialing Process in Auto-attendant work Mode.....	16
3.9.3 Called Extension Busy Process.....	17
3.9.4 Called Extension No Answer Process.....	17
3.10 Add Prefix Digits for Intercom CID.....	17
3.10.1 Add Digits for Intercom CID.....	17
3.10.2 Disable Add Digits for Intercom CID.....	18
3.11 Dial-out Mode Setting.....	18
3.11.1 Set Indirect-Dialing-Out Mode for All Ext.....	18
3.11.2 Set Indirect-Dialing-Out Mode for Certain Ext.....	18
3.11.3 Set Direct-Dialing-Out Mode for All Ext.....	18
3.11.4 Set Direct-Dialing-Out Mode for Certain Ext.....	18
3.12 Call Restriction-Class Assignment.....	19
3.12.1 Class Settingt for All Extensions.....	19
3.12.2 Set Call Class for Certain Extension.....	19
3.13 Set Restriction Item (A/B).....	19
3.13.1 Set Restriction Item A.....	19
3.13.2 Clear Restriction Group of Item A.....	20
3.13.3 Clear All Restriction of Item A.....	20
3.13.4 Set Restriction Item B.....	20
3.13.5 Clear Restriction Group of Item B.....	20
3.13.6 Clear All Restriction of Item B.....	21
3.14 Set Special Outgoing Number.....	21
3.14.1 Set Special Outgoing Number for Class 0.....	21
3.15 Call Duration Restriction Setting.....	21
3.15.1 Call Duration Restriction Setting.....	21
3.15.2 Clear Call Duration Restriction.....	21
3.16 Ext Access C.O.Line.....	22
3.16.1 Set Ext Access Certain C.O. Line in day mode.....	22
3.16.2 Set Ext Access C.O.Line in night mode.....	22
3.17 Set Fax Ext and Enable/Disable Auto Fax Detect function(Optional only for higher version MS+ series).....	22
3.18 Ext Number Flexible coding.....	23
3.18.1 Set Extension Number (Change the Ext. Number).....	23
3.18.2 Restore to Original Extension Numbers.....	23
3.19 Ringing/Transfer/Reservation time.....	23
3.19.1 Internal Call Ringing Time.....	23

3.19.2	Call Transfer Ringing Time.....	23
3.19.3	No Answer Call forwarding Time.....	24
3.19.4	C.O Line Reservation Time.....	24
3.20	Transfer Operation Setting.....	24
3.20.1	External Call Transfer Mode.....	24
3.20.2	Extension No Answer Process for External Call Transfer... ..	24
3.20.3	Enable/disable Call Forward Setting reserved when Power Failure.....	24
3.21	Ext. Group Setting.....	25
3.21.1	Set Ext. Group Number.....	25
3.21.2	Add members in Ext. group.....	25
3.21.3	Set the Ext. Group work mode.....	25
<b>Chap 4</b>	<b>Operating Instruction.....</b>	<b>26</b>
4.1	Day/Night Work Mode Setting.....	26
4.1.1	Manual Mode Setting.....	26
4.1.2	Automatic Mode Setting(Optional only for higher version MS+ series)	26
4.2	Set & Clear other Ext. Call forward through Programming Extensions	26
4.3	Outgoing Call.....	27
4.3.1	Outgoing Call Dial 9 at first (or Dial Directly).....	27
4.3.2	Outgoing Call by Accessing C.O Line (except for108).....	27
4.3.3	Automatically Call back when CO line is busy.....	28
4.3.4	Outgoing Call Transfer (Secretary Function).....	28
4.4	Intercom Call.....	28
4.4.1	Intercom Call in Indirect-Dialing-Out Mode.....	28
4.4.2	Intercom Call in Direct-Dialing-Out Mode.....	29
4.5	Answer call.....	29
4.5.1	Answer Call in Operator Work Mode.....	29
4.5.2	Answer Call in Auto-attendant Work Mode.....	29
4.5.3	Call Pick Up.....	29
4.6	C.O. Line Reservation (except 108).....	30
4.7	Call Transfer(External Call).....	30
4.7.1	Call transfer to another Extension.....	30
4.7.2	Call Transfer to Ext.Group.....	31
4.8	Call switch (call pick up during conversation) (except 108).....	31
4.9	Secretary Function(Outgoing Call Transfer Function).....	31
4.10	Three Way Conference (1 C.O Line and 2 Ext).....	32
4.11	Call Forward.....	32
4.11.1	Call Forward Always.....	32
4.11.2	Call Forward When Ext is busy or no answer.....	33
4.11.3	Set Call Forward(to external number)talking time.....	33
4.12	Ext. Number Query.....	34
4.12.1	Display Ext number on Caller ID phone.....	34
4.13	Priority Access(Call Monitor).....	34
4.14	Call Operator Directly.....	35

4.15 Internal Hotline Function.....	35
4.16 Do Not Disturb(DND).....	35
4.16.1 Set Do Not Disturb(DND).....	35
4.16.2 Clear Do Not Disturb(DND).....	35
4.17 Clear Extension Function Setting.....	35
4.18 Call All Extension(Group Call).....	36
<b>Chap 5 Maintenance&amp;Troubleshooting.....</b>	<b>36</b>
5.1 Outgoing calls can't be made.....	36
5.2 Outside calls can't dial in.....	36
5.3 Intercom can't be made.....	36
<b>Chap 6 Glossaries.....</b>	<b>37</b>
<b>Chap 7 Default Settings.....</b>	<b>38</b>
<b>Chap 8 System Programming &amp; Operation Instruction.....</b>	<b>39</b>
8.1Index of Basic Operation.....	39
8.2 Index of system programming.....	40
<b>Appendix I Door-phone Function.....</b>	<b>43</b>
I.1 Connection instruction.....	43
I.2 Set Door-phone function.....	44
I.2.1Set the port of Door phone.....	44
I.2.2 Door phone ringing Extension Setting.....	44
I.2.3 Set Duration of switch Signal.....	44
I.3 Operating Instruction.....	44
<b>Appendix II Least Cost Routing (LCR) Setting.....</b>	<b>45</b>
II.1 Instruction for LCR.....	45
II.2 Programming setting.....	45
II.3 Operating instruction.....	47
<b>Appendix III Auto Add Prefix number dialing.....</b>	<b>47</b>
III.1 Programming setting.....	48
III.2 Enable/Disable prefix number add Dialing function.....	48
III.3 Prefix Number Setting.....	48
III.4 Prefix Number Dialing.....	48
<b>Appendix IV Abbreviated-dialing.....</b>	<b>48</b>
<b>(Memory dialing).....</b>	<b>48</b>
IV.1 Programming setting.....	48
IV.2 Operating instruction.....	49
<b>Appendix V Extension Dynamic Lock.....</b>	<b>49</b>
V.1 Set the password of dynamic lock.....	49
V.2 Locking setting.....	49
V.3 Unlocking setting.....	49
V.4 Initialization / Clear the password.....	49

# Chap 1 Brief Introduction & Features

## 1.1 System Overview

With the design and production according to G.712 and G.732 protocol of CCITT, this system integrates virtues of various practical function of PABX, and it has unique advantage in innovation. As a type of new generation with over 50 powerful functions for business and management, it has wide application in small business, like SOHO, small offices, villa...etc. In a word, it is an ideal equipment for customer to enhance communication condition, improve work efficiency, control toll expenditure, and make office intelligent come true.

## 1.2 Features

- Operator/Auto-attendant work mode
- OGM(Outgoing Message, DISA:20s or 60s, 90s for option)
- Caller ID
- Call transfer
- Call forward
- Call pickup
- Call restriction
- C.O line booking
- C.O line reservation
- Ext number flexible coding
- Outgoing call transfer
- Internal hotline
- Music on hold
- Do not Disturb(DND)
- Multiple Dial out mode
- Three party conference
- Abbreviated dialing(Memory dialing)
- Extension Dynamic Lock
- Intelligent routing(LCR)
- Extension group
- Fast dial Ext. in OGM mode
- Door phone & door opener
- Remote programming
- Power failure transfer
- Multiple communication channel(7 path)
- Programming can be made by normal phone, no need special key phone

# Chap 2 Installation & Connection

## Before Installation

For easy and quick installation, it is strongly recommended that user read and follow the following instruction carefully so as not to damage the system accidentally by incorrect operation.

### 2.1 System Appearance

● **NOTE:**

1. For 108 & 208, the 1 CO.interface pin1 & pin4 is a relay output port for door lock, pin 2 & pin3 is for CO line. As picture:
2. For 208 & 308, the 3 CO.interface pin1 & pin4 is a relay output port for door lock, pin 2 & pin3 is for CO line. As picture:

For 108 view

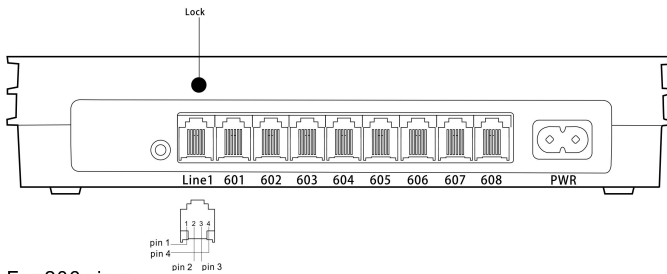

For 206 view

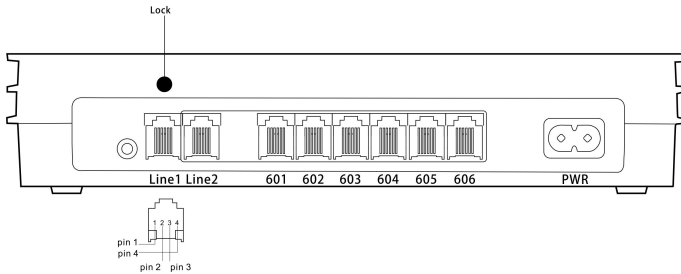

For 208 & 308 view

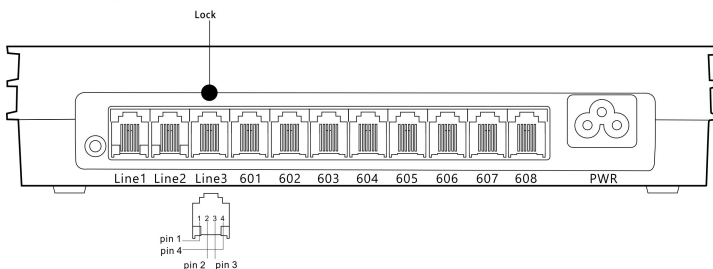

**3. For music interface is for external holding music input (connect to MP3 player).**

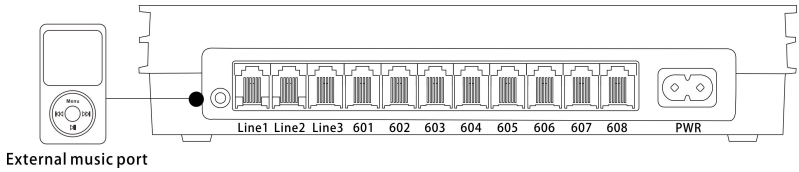

**Front View:**

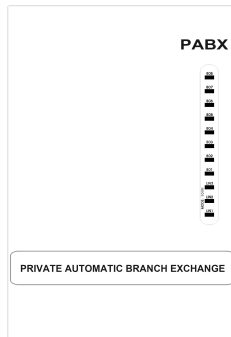

**108 View**

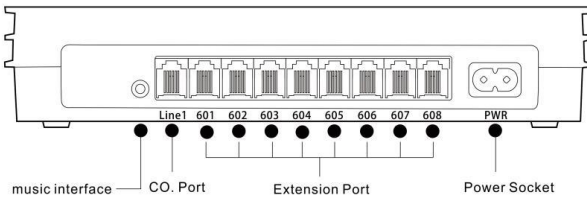

**206 View**

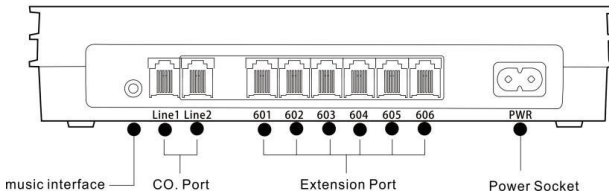



### 208 & 308 View

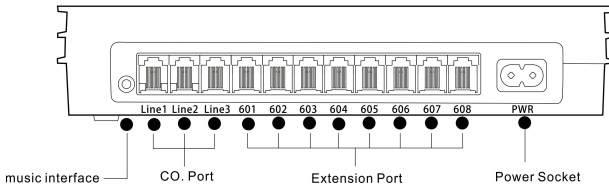

### 208/308 Connection Diagram:

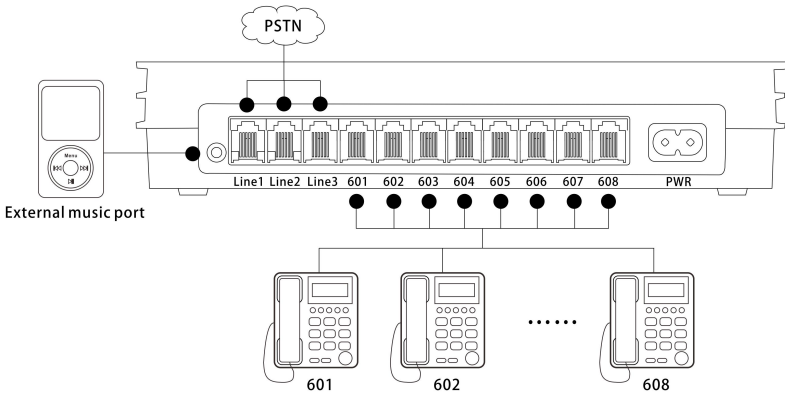

## 2.2 Technical Parameter

Power Supply Voltage .....	AC 220V or AC 110V, 50-60Hz
Power Dissipation.....	≤20VA
Exchange Mechanism.....	Analog spatial division
Type of Telephone.....	Dual Tone Multi-Frequency
Communications Lines.....	108/206/ 208/308---7
IC Power Supply.....	±5V
Distortion.....	≤10%
Ringing Voltage .....	AC 70V±10% 50HZ
Crosstalk Attenuation.....	≧ 70 dB
Transmission Loss.....	0.37 dB

## 2.3 Attention

Please pay attention to the important items of installation:

- The telephone exchange shall be installed in a stable indoor place with dry, ventilated environment. (Temperature Range: 0-45°C, Humidity Range: 20%-80%. Avoid straight sun shine or in the environment of flammable or caustic gas.) Special telephone wire is preferable.

- A marginal space around the exchange should be remained for heat sink, inspection and maintenance of the system.
- A wall bore is available at the underside of mainframe for wall installation. Desk installation is also admitted. But the contact of wall bolt and circuit board inside the mainframe should be avoided.
- Please keep the exchange away from other equipment producing large electromagnetic disturbance (such as motor and large transformer).
- None of the wiring of any extension should share the pipeline with power supply or antenna. Neither should the extension be close to antenna for air broadcasting (including short-wave).
- Avoid damaging the power-supply cable. Keep it away from water. Encountering the leakage of water cut off the power immediately.
- Please don't impact or shake the exchange at any situation. Don't remove the exchange in working status.
- If the wiring pipeline of the extension is disturbed by electromagnetic wave while substitution is unavailable in site, special insulating wire for communication is suggested for substitution, also, the insulating net of which should be grounded.

## 2.4 Warning

- The wiring should not be done in thundering.
  - Avoid using telephone in thundering.
  - Please don't use the telephone in flammable and leaking gas environment.
  - Unless the equipment is disconnected, please don't touch the broken part of the wiring or any connection ends.
- ◆ **Note: Lightning stroke is an accident, which will not be regarded as normal maintenance.**

## 2.5 Installation procedure

### 2.5.1 Connecting C.O. lines & extensions to the unit

- Please connect the RJ11 crystal head with EXT port and C.O port separately;
- Make sure to avoid short circuit.
- Connecting extensions according to the in-dilated extension positions and C.O. lines to the corresponding line ports on the unit.

### 2.5.2 Zero-load power-on inspection:

- The operation voltage of this product is AC220V or AC110V. Check out the voltage of local power supply. A UPS backup is highly recommended.
- Plug in the power supply line, indicating normal power supply and

working state of the PBX.

- Pick up the handset of extension 601. If you can hear an internal dial tone indicates that the system is working normally. You can start to operate it now.

## **2.6 Direct Access when Power Failure**

The C.O. lines will be connected directly to the specific Ext automatically when power is failure. The No.1 C.O. line will be connected to Ext. 602 and No.2 to Ext.603, No.3 to Ext.604, So you can only use the three Ext as normal phone with direct C.O. line (206: Only No.1 C.O. line can be connected to Ext.601 directly, i.e. No.2 C.O. line cannot be connected directly when there is power failure.)

For example when someone call in with No.1 C.O. line when power is failure, the Ext.602 will ring, you can only pick up Ext. 602 and talk with the caller.

## Chap 3 System programming

### 3.1 Before programming

- All the programming must be performed on the extension 601 or 602 or 603 or 604; all the programming must be done in programming status.
- All the extension must be dual tone multi frequency phone.
- You can programming one by one, and end the process by pressing #. You don't have to hang up if something wrong occurs, you could press \* to restart.
- If programming extension(601,602,603,604)is in Direct-Dial-Out mode, you need to press \* to enter internal status, then start programming.
- When the setting is finished, a long beep indicates that the setting is done correctly and saved in the system. If instead an array of short chirps is heard, that indicate an error occurred in the setting. You need to check and restart the setting. It is only after the end with the long beep you can continue with another operation step.



How to programming

At first you must enter into system programming status(details please refer to 3.2.1 instruction).

### 3.2 Basic Command

#### 3.2.1 Enter into System Programming Status

**Format:** # \* EFGH

Explanation: EFGH is the system password, default is 0000.

Example: To programming the system, you should input system password at first, if the password is 5678, as below:

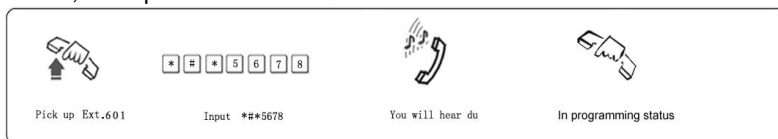

- You need to dial: \* # \* EFGH in Direct-Dialing-Out mode.
- The default password is 0000, so you need to input \*#\* 0000 at the first time when operate this system.
- Programming Ext is EXT.601, or EXT.602, or EXT.603, or EXT. 604

#### 3.2.2 Change the Password

**Format:** 09EFGH#

Explanation: EFGH is the new password.

**Description:** to change the password.

Example: Change the system password from “0000” to “5678”

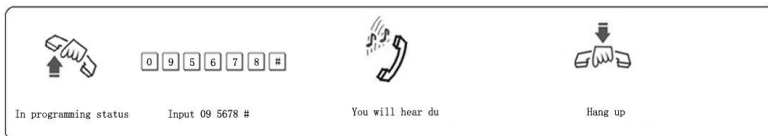

We suggest changing the password before set up this system.

### 3.2.3 Flash Time Setting

**Format:** 00F #  
 F=1 -----0.8s  
 F=2 -----1.0s  
 F=3 -----1.2s  
 F=4 -----1.5s  
 F=5 -----1.8s

**Explanation:** F means the flash time.

**Description:** To active the hold and transfer operating use.

On default setting: F=2 (1.0s)

**Example:** Set the flash time to 1.2S

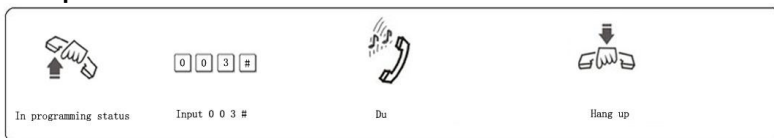

### 3.2.4 System Restore Default Setting

**Format:** 0000 #

**Description:** System will restore the default factory setting.

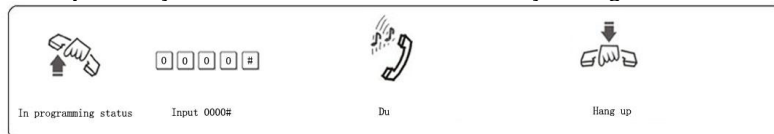

This command has no influence on the status of enabling/disabling C.O. line.

### 3.2.5 Set Delay time for outgoing call transfer

**Format:** 03TT #

**Description:** TT=01-99, unit is second; it means the time which is from finish dialing the last number to the system start to allow call transfer function, The system restriction time also from this time.

**Default setting:** Duration of time-delay being 5 seconds.

**Example:** Set delay time: 8s, then input 0308# in programming status.

### 3.3 Enable/Disable C.O. Lines

You must use these command according to the actual CO line connected before use the PBX. If you don't enable any C.O. line, system will define no C.O. line connected and will not auto detect C.O. line!!!

#### 3.3.1 Enable All C.O. Lines

**Format:** 0600#

**Description:** Enable all C.O. lines

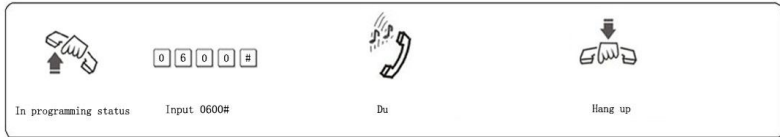

On default setting: system is in CO line disabled status.

#### 3.3.2 Disable All C.O. Lines

**Format:** 0610#

**Description:** Disable all C.O. lines

#### 3.3.3 Enable No. M C.O. Line

**Format:** 060M#

**Explanation:** M: C.O. Line port No. M = 1 - 3

**Description:** Enable the No.M C.O. line

**Example:** You have a 308 PBX, you want to use C.O. line 1 and C.O. line 2, but the line 3 is not occupied.

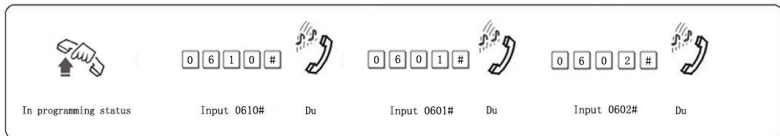

#### 3.3.4 Disable No.M C.O. Line

**Format:** 061M#

**Explanation:** M: C.O. Line port No. M = 1 - 3

**Description:** Disable the No.M C.O. line

### 3.4 Day/night mode & weekend mode setting

#### 3.4.1 System Date/Time setting (Optional for higher version MS+ series only)

**Format:** 01YYMMDD# Set year/month/date of system

**Explanation:** ●YY: year, 00-99 ●MM: month, 01-12 ●DD: date, 01-31

**Format:** 02 HHTT# Set Hour/Minute of system

**Explanation:** ● HH: hour, 00-23, 24 hours mode ● TT: minutes, 00-59

**Format:** 020000W # Set week of system

**Explanation:** W: Week, 1-7(7 = Sunday)

**Example:** Set system to 2002/12/18 21:30 Sunday

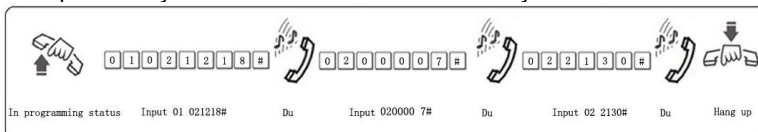

### 3.4.2 Day/night mode setting

**Format:** 0 4 0 # Set day/night mode to automatically mode  
 0 4 1 # Set day/night mode to manual mode  
 0 4 2 HH TT # day mode start time, HH-hour (24), TT-minute  
 0 4 3 HH TT # day mode end time, HH-hour (24), TT-minute  
 0 4 4 0 # Enable auto-attendant(OGM) in day and night  
 0 4 4 1 # Enable auto-attendant in day ( means in night is operator mode )  
 0 4 4 2 # Enable auto-attendant in night ( means in day is operator mode )

0440#,0441#,0442# setting must be used after set Operating mode ( refer 3.5.3 or 3.5.4 ) to auto-attendant.

Remark: Auto mode and time setting is only optional for higher version MS+ series.

### 3.4.3 Weekend mode setting (Optional for higher version MS+ series only)

**Format:** 0 4 8 0 # enable weekend mode function  
 0 4 8 1 # disable weekend mode, this is default setting  
 0 4 9 0 0 # to set from Monday to Sunday as work day ; this is default setting  
 0 4 9 0 W # to set week W as work day  
 0 4 9 1 0 # to set from Monday to Sunday as weekend day  
 0 4 9 1 W # to set week W as weekend day.

Explanation: W: Week, 1-7(7 = Sunday)

**Description:** Weekend mode means when the day in week is set to work day, then the day/night mode will be changed according the setting in 3.4.1 & 4.1, and when the day is defined to weekend day,then the system is in night mode.

**Example:** To set Monday to Friday as work day,and Saturday and Sunday as weekend day, then input 04900#, 04916#, 04917#, 0480#, also you should set day/night mode to automatically mode and day mode start & end time.

### 3.5 Set Operating mode

◆ **NOTE:** On default setting, all the C.O. lines is in operator work mode , the operator ringing Extension is 601 and 602.

#### 3.5.1 Set Auto-attendant work Mode (OGM) for All C.O. Lines

**Format:** 1 0 #

**Description:** Set all C.O. line in Auto-attendant work mode. In this mode, caller will hear the recorded greeting message, while all extensions are in mute status.

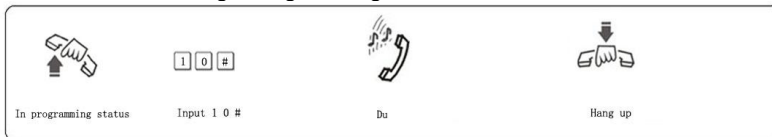

☞ If the caller doesn't know the extension number, he can inquire to the operator by dialing "0".

• The greeting message(Outgoing Message,OGM) should be recorded when set this mode.

#### 3.5.2 Set Operator work mode for all C.O. Lines

**Format:** 11#

**Description:** Set all C.O. lines in Operator work mode. In this mode, the operator extension and other ringing extensions will ring when an incoming call is received.

#### 3.5.3 Set Auto-attendant Mode (OGM) for Certain C.O. line

**Format:** 10M #

**Explanation:** M: C.O. line No. M=1-3

**Description:** Set No.M C.O. lines in Auto-attendant work mode (DISA --Direct Inward System Access status).

**Example:** Set C.O. line 2 and 3 in Auto-Attendant work mode, the other C.O. line in operator work mode.

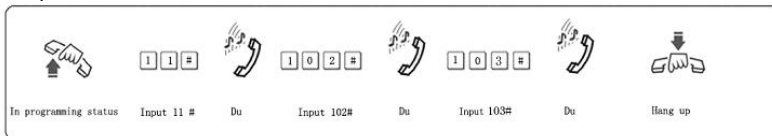

☞ If the caller doesn't know the extension number, he can inquire to the operator by dialing "0".

• The greeting message(Outgoing Message,OGM) should be recorded when set this mode.

#### 3.5.4 Set Operator work mode for Certain C.O. line

**Format:** 11M#

**Explanation:** M: C.O. line No. M=1-3



**Description:** Set No.M C.O. line in Operator work mode.

**Example:** Set C.O. line 1 and 3 in operator mode, other C.O. line in Auto-attendant mode.

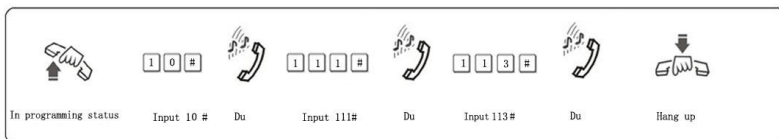

### 3.5.5 Enable/Disable fast dialing in OGM mode

**Format:** 1546# Disable fast dialing function, this is default setting  
 1547# Enable fast dialing function.  
 1548# Disable fast dialing Ext group function  
 1549# Enable fast dialing Ext group function

**Description:** when this function is enabled, in auto attendant mode, caller dial 1 to ext. 601, dial 2 to ext. 602, dial 3 to ext. 603..... dial 8 to 608, . dial 0 to operator ext.

### 3.5.6 CRBT (Directly ring while play OGM Process in Auto-attendant Mode)

**NOTE:** ◆ This function allow the outside caller hear OGM while the system directly ring extension without dialing any extension numbers.

- ◆ You should set the C.O.line in Auto-attendant mode at first.
- ◆ In this mode we suggest you record the OGM in one section.

**Format:** 1 67 # this is default setting

**Description:** disable directly ring extension while playing OGM in auto-attendant mode.

**Format:** 1 6 7 0 #

**Description:** enable directly ring extension while playing OGM in auto-attendant mode,and the ringing extensions is the first & the second operator.

**Format:** 1 671# to ring the first Ext. Group

**Format:** 1 672# to ring the second Ext. Group

**Description:** Enable directly ring extensions while playing OGM in auto-attendant mode,and the ringing extensions is the Ext. Groups.

**Format:** 1 6 7 6 #

**Description:** Enable directly ring extension while playing OGM in auto-attendant mode, The system will call the operator mode ringing Extension.

## 3.6 OGM setting (Outgoing Message)

This system has one OGM with 20 seconds(default) recordable time.

### 3.6.1 Set OGM section mode

The system use maximum four section of OGM messages, and can

be set in four modes, see below:

**Format:** 0451# Set OGM in one section mode  
0452# Set OGM in two section mode

**Description:** In two section mode, it is day/night mode, while in day time system use the first section, in night time system use the second section.

**Format:** 0453# Set OGM in three section mode;  
(this is default setting)

0454# Set OGM in four section mode

**Description:** In four section mode, while in day-time the system use the first three section message, in night-time the system use the fourth section message)(**Note: this mode is only available when OGM recordable time is 60s or 90s**)

### 3.6.2 OGM recordable time

#### For 20 seconds type(standard type)

- ◆ In one section mode is total 20 seconds.
- ◆ In two section mode, each section is 10seconds
- ◆ In three section mode, the first section is 8 seconds, the second & the third section is 6 seconds

#### For 60 seconds type(optional for higher version MS+ series)

- ◆ In one section mode is total 60 seconds.
- ◆ In two section mode, each section is 30seconds
- ◆ In three section mode, each section is 20seconds
- ◆ In four section mode, the first & fourth section is 20seconds,the second & the third section is 10seconds

#### For 90 seconds type(optional for higher version MS+ series)

- ◆ In one section mode is total 90 seconds.
- ◆ In two section mode, each section is 45seconds
- ◆ In three section mode, each section is 30seconds
- ◆ In four section mode , the first & forth is 30 seconds , the second & the third section is 15 sections .

### 3.6.3 OGM Recording(multiple section mode)

**Format:** 1 2 M # ( M=1,2,3, 4, the section of the OGM )

**Description:** to record an greeting message for Direct Inward System Access(DISA).

**OGM 1** recording, this is the first OGM, usually it is for company greeting, for example, you may record "This is ABC company, please dial extension number or dial "0" for operator. Thanks for your call."

**OGM 2** recording, this is the second OGM, usually it is for C.O. line dial extension and this extension is busy, if you want to transfer this calling to other extension, you may record "Sorry! This extension is busy. please dial other extension number or dial "0" for operator."

**OGM 3** recording , this is the third OGM, usually it is for C.O. line dial extension and this extension no answer, you may record "Sorry! This

extension do not answer, please dial other extension number or dial “0” for operator.”



- The recording time is limited, when you hear a beep tone “du” to start recording and another beep tone “du” to end recording;
  - The new message will overwrite the old one;
  - Please use high quality telephone to ensure high quality of recording;
  - If the caller dial a number before the system finish playing the message, the system will terminate playing the message, waiting for the caller to continue with dialing;
  - The call will be forwarded to Operator if caller dial 0.

### 3.6.4 OGM playing(multiple section mode)

**Format:** 13 M # ( M=1,2,3, 4, the section of the OGM )

**Description:** Check and review the recorded message, if you are not satisfied, you can record again.

### 3.6.5 One section OGM Mode

**Format:** 1200 #

**Description:** to recording one section OGM

**Format:** 1300 #

**Description:** to play and check one section OGM

## 3.7 Review the Holding Music

**Format:** 14 #

**Description:** Perform the music on holding melody or test the quality of telephone unit.



## 3.8 Set Operator and Ringing Extension

### 3.8.1 Set Operator

**Format:** 15N #

**Explanation:** N: the Ext. port No., N=1-8

**Description:** To assign any Ext as the operator. In the default setting, Ext 602 is the operator.

**Example:** Set Ext.602 as operator

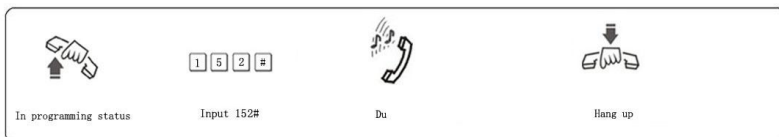

### 3.8.2 Set Ringing Extensions in Day mode

**Format:** 3 0 M N 0 #

**Explanation:**

M: the C.O. Line port No. M=1 - 3

N: the Ext. port No. N=1-8( N=1 means Ext.601 ..... N=8 means Ext.608)

**Description:** In operator work mode when incoming call from No.M C.O. line arrives and system in day mode(in default setting system in day mode), No. N Ext. will ring.

**In default setting only Ext601, 602 will ring.**

**Format:** 3 0 M N 1 #

**Description:** Disable No. N Ext. ring when incoming call from No. M C.O. line arrives.

**Format:** 3 0 M #

**Description:** Disable all Ext ring when incoming call from No. M C.O. line arrives.

**Example:** Set Ext.605 and Ext.607 and EXT.608 ring when call from C.O. line 2 arrives while the system in day mode, then input 302#, 302050#, 302070#, 302080#.

### 3.8.3 Set Ringing Extension n Night mode

**Format:** 3 1 M N 0 #

**Description:** In operator work mode when incoming from No. M C.O. line arrives and system is in night mode, Ext N will ring.

**In default setting only Ext 601, 602 will ring.**

**Format:** 3 1 M N 1 #

**Description:** Disable No. N Ext. ring when incoming call from No.M C.O. line arrives while system in night mode.

**Format:** 3 1 M #

**Description:** Disable all Ext ring when incoming call from No.M C.O. line arrives while system in night mode.

**Example:** Set Ext.603 and Ext.605 ring when incoming call from C.O. line 2 arrives while the system is in night mode, then input 312#, 312030#, 312050#.



●You can set up to 8 Ext ring at the same time for one C.O. line while system in either day or night mode, that mean you can repeat to input 30MN0# or 31MN0# for 8 times.

●Before you set certain ringing extension, we suggest you'd better disable all the Exts ring for this C.O. line.

●This function must be set in Operator work Mode.

- This function only for C.O. line Incoming call.

### 3.8.4 Set C.O.lines ringing mode

**Format:** 380# Set all the C.O line ring is in normal mode(operator ringing extension will ring simultaneously,this is default setting)

381# Set all the C.O line ring is in round robin mode (operator ringing extension will ring one by one)

499TT# Set the ringing time in round robin mode (TT=01-99, unit is second, default TT=10, that is 10s)

**Description:** When C.O line is in round robin ringing mode, the incoming call will ring operator ringing extension one by one. For example, the default operator ringing extension is 601 and 602, the call will ring 601 at first, after 10s, will ring 602.

### 3.8.5 Ringing mode when all the ringing extensions is busy

**Format:** 1 8 8 0 #

**Description:** When C.O.line incoming call arrives, and all the ringing extensions assigned to C.O. line is busy, system will send prompt beep tone to the ringing extensions every five seconds. this is default setting.

**Format:** 1 8 8 1 #

**Description:** When C.O.line incoming call arrives, and all the ringing extensions assigned to C.O. line is busy, instead of sending prompt beep tone, the system will search the first available extension from Ext. 601 to Ext. 608 in sequence then ring it.

**Format:** 1 8 8 2#

Disable sending prompt beep tone when ringing extension is busy

**Format:** 1 8 8 3#

Enable sending prompt beep tone when ringing extension is busy



This setting is only valid when system is in operator work mode

## 3.9 C.O.Line Call Process in Auto-attendant Mode

### 3.9.1 OGM busy Process in Auto-attendant work Mode

**Format:** 1 5 4 0 #

**Description:** when CO line incoming call arrives and OGM is busy, then the call is in waiting status(no extensions ring),this is default setting.

**Format:** 1 5 4 1#

**Description:**When multiple CO line incoming call arrives, as this system only has one OGM, you can set some call is in waiting status, some call ring operator ringing extension(refer 3.8.2 & 3.8.3).

### 3.9.2 No dialing Process in Auto-attendant work Mode

**Format:** 1 6 0 #

**Description:** In auto-attendant work mode, if the C.O. Line caller doesn't dial the extension number over 5 seconds, then the C.O. line will be cut off. This is the default setting.

**Format:** 1 6 1 #

**Description:** In auto-attendant work mode, if the C.O. Line caller doesn't dial the extension number over 5 seconds, then the C.O. line will be transferred to operator or the Ext.Group.

### 3.9.3 Called Extension Busy Process

**Format:** 165#

**Description:** In auto-attendant work mode, if the C.O. Line caller dial some extension, but it is busy, then the CO line will be cut off, this is the default setting.

**Format:** 1650#

**Description:** when the called extension is busy, the call will be transferred to operator.

**Format:** 1655#

**Description:** when called ext.busy, send prompt beep tone to the extension.

**Format:** 1656#

**Description:** when the called extension is busy, the call will be transferred to operator ringing extension.

◆ Above setting is just valid for one section OGM mode.

### 3.9.4 Called Extension No Answer Process

**Format:** 166#

**Description:** when the called extension no answer, the C.O. line will be cut off; this is the default setting.

**Format:** 1660#

**Description:** when the called extension no answer, the call will be transferred to operator.

**Format:** 1666#

**Description:** when the called extension no answer, the call will be transferred to the operator ringing extension.

◆ Above setting is just valid for one section OGM mode.

## 3.10 Add Prefix Digits for Intercom CID

### 3.10.1 Add Digits for Intercom CID

**Format:** 180 KK #

**Description:** Add KK in intercom Caller ID number

 ●Some telephone can not display the caller ID number less than 4 digits, so we need to add some prefix digit.

●Default setting: KK=00 ,CID number will add two digit 00.

### 3.10.2 Disable Add Digits for Intercom CID

**Format:** 180 #

**Description:** Disable add digits for intercom Caller ID

## 3.11 Dial-out Mode Setting

### 3.11.1 Set Indirect-Dialing-Out Mode for All Ext

**Format:** 21#:

**Description:** Set Indirect-Dialing-Out mode for all Exts(dialing 9 for outgoing).

### 3.11.2 Set Indirect-Dialing-Out Mode for Certain Ext.

**Format:** 2N1#

**Explanation:** N: the Ext. Port No., N = 1 - 8

**Description:** Indirect-Dialing-Out mode for Ext. N (dialing 9 for outgoing).

**Example:** Set Indirect-Dialing-Out mode for Ext.608

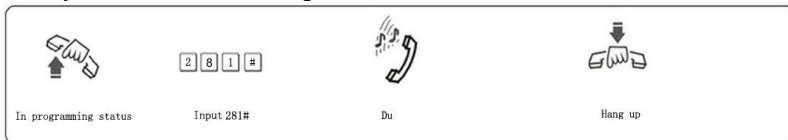

On default setting, this system is in Indirect-Dialing-Out mode

### 3.11.3 Set Direct-Dialing-Out Mode for All Ext.

**Format:** 20#

**Description:** Set Direct-Dialing-Out mode for all Ext(dial outgoing number directly)

### 3.11.4 Set Direct-Dialing-Out Mode for Certain Ext.

**Format:** 2N0#

**Explanation:** N: the Ext. Port No., N = 1 - 8

**Description:** Set Direct-Dialing-Out mode for Ext.N.

**Example:** Set Direct-Dialing-Out mode for Ext.607

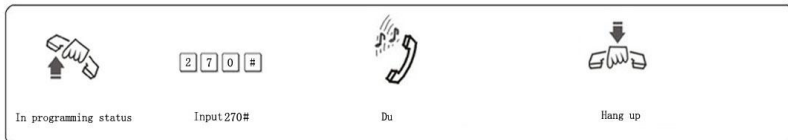

• In Direct-Dialing-Out mode, extension should dial \* + Ext number for intercom call.

- No need dial 9 for outgoing call.

## 3.12 Call Restriction-Class Assignment

### 3.12.1 Class Setting for All Extensions

**Format:** 40 L#

**Explanation:** L: Class number, L= 0 - 6

**Description:** Set dialing-out class L for all Exts.

L=1: no any restriction

L=2: outgoing with restriction of IDD(International Direct Dialing)

L=3: outgoing with restriction of DDD(Domestic Direct Dialing)

L=4: outgoing with restriction of the prefix item A.

L=5: outgoing with restriction of the prefix item B.

L=6: only for intercom call.

L=0: only for some special outgoing number

**Example:** Set call class 3 for all extensions.

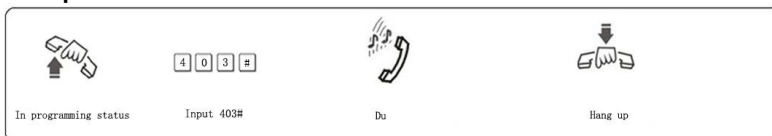

 On default setting, the class for all extensions is 4.

### 3.12.2 Set Call Class for Certain Extension

**Format:** 40 N L#

**Explanation:** N: the Ext. port No., N = 1 - 8

L : class number, L= 0 - 6

**Description:** Set dial-out class L for certain Ext. N

**Example:** Set class 3 for Ext.606

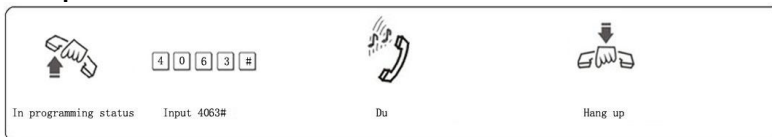

## 3.13 Set Restriction Item (A/B)

### 3.13.1 Set Restriction Item A

**Format:** 4 1 Q ABCD#

**Explanation:**

ABCD: the prefix digits of the outgoing number to be restricted, it can be from 1-digit to 4-digits, it should be ended with # if less than 4-digits.

Q: the group series from 01 to 16.

**Description:** to restrict the outgoing number start with ABCD

**Example:** Ext.608 is assigned dialing-out class 4, now you want Ext.608 can't dial the numbers with initial digits – 573,168



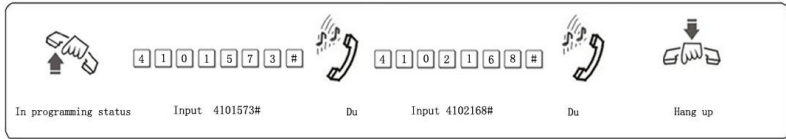

- Item A can restrict 16 groups of initial digits.
- Restrict Item A only valid for dialing-out class 4.

### 3.13.2 Clear Restriction Group of Item A

**Format:** 41 Q #

**Explanation:** Q: the group series from 01 to 16.

**Description:** to clear the outgoing restriction of numbers in group Q.

**Example:** you want to clear the outgoing restriction of numbers with initial digits—573 of group 01,



### 3.13.3 Clear All Restriction of Item A

**Format:** 41 #

**Description:** to clear all the outgoing restriction numbers of item A

### 3.13.4 Sel Restriction Item B

**Format:** 42 Q ABCD#

**Explanation:** the prefix digits of the outgoing number to be restricted, it can be from 1-digit to 4-digits, it should be ended with # if less than 4-digits.

Q: the group series from 01 to 16.

**Description:** to restrict the outgoing number starting with ABCD

**Example:** Ext.606 is be assigned dialing-out class 5, now you want Ext.606 can not dial the numbers with initial digits – 575,161

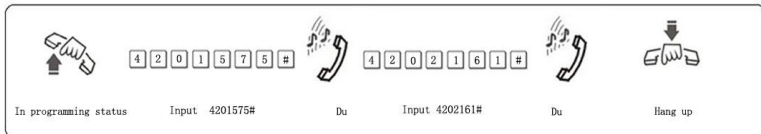

- Item B can restrict 16 groups of initial digits.
- Restrict Item B is only valid for dialing-out class 5.

### 3.13.5 Clear Restriction Group of Item B

**Format:** 42 Q #

**Explanation:** Q: The group series from 01 to 16.

**Description:** to clear the outgoing restriction of numbers in group Q.

### 3.13.6 Clear All Restriction of Item B

**Format:** 4 2 #

**Description:** to clear all the outgoing restriction of numbers item B

## 3.14 Set Special Outgoing Number

### 3.14.1 Set Special Outgoing Number for Class 0

**Format:** 4 3 P ABCD#

**Explanation:** ABCD: the prefix digits of the outgoing number to be restricted, it can be from 1-digit to 4-digits, it should be ended with # if less than 4-digits.

P --- The group series from 01 to 16.

**Description:** Allow to dial the phone numbers starting with <ABCD> only.

**Example:** Ext.605 is set as class 0, now you want Ext.605 can dial the numbers with initial digits – 0592,179

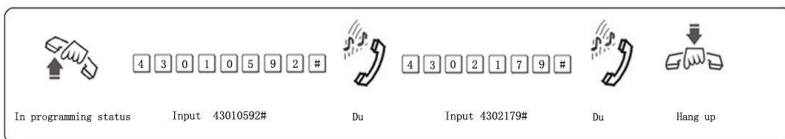

- 16 groups of initial digits can be set.
- This function is only valid for dialing-out class 0.

## 3.15 Call Duration Restriction Setting

### 3.15.1 Call Duration Restriction Setting

**Format:** 6NTT#

**Explanation:** N: the EXT port No. (N = 1 – 8)

TT: the duration restriction(2 digits), TT=01-99(minutes)

**Description:** set the Ext N outgoing call duration within TT minutes. This function can only restrict the duration of outgoing call.

**Example:** Set Ext.604 outgoing call duration within 8 minutes

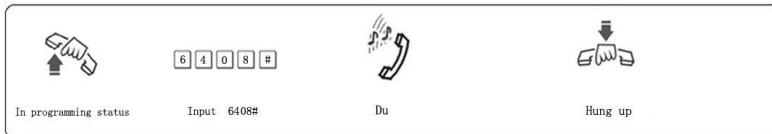

### 3.15.2 Clear Call Duration Restriction

**Format:** 6N00#

**Explanation:** N : the EXT port No. (N = 1 - 8)

**Description:** Clear the Ext N outgoing call duration restriction.

**Example:** Clear the Ext.604 outgoing call duration restriction.

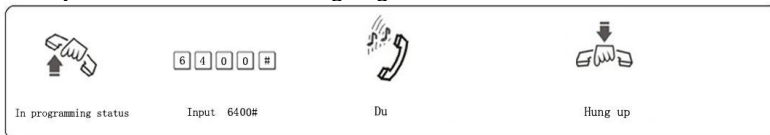

## 3.16 Ext Access C.O.Line

### 3.16.1 Set Ext Access Certain C.O. Line in day mode

**Format:**

- 70MN0# Set extensions N access C.O line M in day mode.
- 70M0# Set all extension can access C.O line M in day mode.
- 70M1# All extensions can not access C.O line M in day mode.
- 70MN1# Restrict EXT.N to access C.O line M in day mode
- 70N2# Set EXT. N can access all C.O.line in day mode.
- 70N3# Restrict EXT.N can access all C.O.lines in day mode.

### 3.16.2 Set Ext Access C.O.Line in night mode

◆ **Note: If you not set day/night mode, you don't need to do this setting.**

**Format:**

- 71MN0# Set extensions N access C.O line M in night mode.
- 71M0# Set all extension can access C.O line M in night mode.
- 71M1# All extension can not access C.O line M in night mode.
- 71MN1# Restrict EXT.N to access C.O line M in night mode.
- 71N2# Set EXT. N can access all C.O.line in night mode.
- 71N3# Restrict EXT.N can access all C.O.lines in night mode.

**Explanation:** M: C.O. Line port No, M =1-3 N: the Ext. port No., N =1-8

**Description:** This functions allow you to assign certain CO line exclusively be accessed by certain extension for outgoing calls and other extensions can't use it for outgoing call.

## 3.17 Set Fax Ext and Enable/Disable Auto Fax Detect function(Optional only for higher version MS+ series)

**Format:** 470# Disable auto fax detect function

470N# Set Ext.N is fax Ext and enable auto fax detect function

471K# Set the fax signal number detected, that is system will recognize the signal as fax when detect number K (on default setting, K =2)

**Description:** In auto-attendant mode, when the call from external fax machine, the system will ring the fax extension.

 This function is only available when system is in auto-attendant work mode.

## 3.18 Ext Number Flexible coding

### 3.18.1 Sel Extension Number (Change the Ext. Number)

**Format:** 9Nabcd#

**Explanation:** N : the extension port number, N = 1 - 8,  
abcd: the new Ext. number, 1 to 4 digit.

**Description:** Change old Ext number to new Ext number “abcd”

**Example:** Change Ext 606 to 806

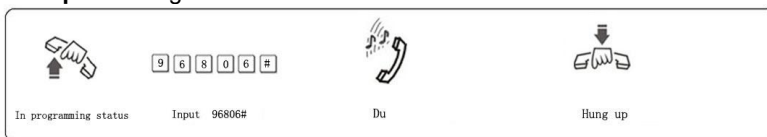

- The new Ext.number range from 1-8999; all numbers can not be in duplicate.
  - The number can not begin with 0 and 9, and can not use the same numbers of two Exts.Group.
  - The length (digits) of new number must keep the same; All the new numbers should be equal digits, and not in duplicate.
  - For example, to set the extension number in 4-digit(8001-8008), you need to dial 918001#, then 928002#, 938003#...one by one, up to 988008.

### 3.18.2 Restore to Original Extension Numbers

**Format:** 9000#

**Description:** Restore Ext number to the default setting, that is: from 601 to 602 603... 606... 608 one by one, etc.

## 3.19 Ringing/Transfer/Reservation time

### 3.19.1 Internal Call Ringing Time

**Format:** 4 9 4 TT#

**Explanation:** TT: seconds 01-99, default setting is 30seconds

**Description:** When one extension call another extension, and the called extension is not picked up, system will continue to ring it with this setting time.

### 3.19.2 Call Transfer Ringing Time

**Format :** 4 9 6 TT#

**Explanation:** TT: seconds 01-99, default setting is 25seconds

**Description:** When transfer a call or incoming call in OGM mode and caller dial some extension number, then the system will ring the called extension with this setting times .

### 3.19.3 No Answer Call forwarding Time

**Format :** 1 8 4 TT#

**Explanation:** TT: seconds 01-99, default setting is 20 seconds

**Description:** When C.O line incoming call ring some extension, but no answer, after TT seconds, the call will be forwarded to another extension.

### 3.19.4 C.O Line Reservation Time

**Format :** 1 8 6 TT#

**Explanation:** TT = 01-99, reservation time is TT \* 10 s

**Description:** Set C.O. line reservation time when Ext. hold the call.



On default setting, TT=12, so the reservation time is 120s.

## 3.20 Transfer Operation Setting

### 3.20.1 External Call Transfer Mode

**Format:** 1 5 3 0 #

**Description:** During call transfer, after flash hook, if transfer extension doesn't dial number within 5 second, will reconnect with C.O line again. Or if transfer extension dial a wrong number or dialed extension is busy, system will send 3 busy tone, then reconnect C.O line.

**Format:** 1 5 3 1 # (this is the default setting)

**Description:** During call transfer, after flash hook, if transfer extension doesn't dial number, system will hold the C.O line until flash hook again to reconnect it. Or if transfer extension dial a wrong number or dialed extension is busy, system will send 10 busy tone, then transfer extension can flash hook again to reconnect with C.O line.

### 3.20.2 Extension No Answer Process for External Call Transfer

**Format:** 1 6 2 # Call back the extension, this is default setting  
1 6 3 # Not call back

**Description:** If the call back extension is busy, system will release the C.O. line.

### 3.20.3 Enable/disable Call Forward Setting reserved when Power Failure

**Format:** 1 7 0 #

**Description:** Call forward setting will lose when power failure.

**Format:** 1 7 1 #

**Description:** Call forwarding setting will be stored when power failure (system default setting)

## 3.21 Ext. Group Setting

### 3.21.1 Set Ext. Group Number

All the extension can be set in 2 groups.

**Format:** 9 9 0 abcd #

**Description:** set the first group number and enable it.

**Format:** 9 9 1 abcd #

**Description:** set the second group number and enable it.

 • The length of Ext group number should be the same with the first extension number

• Ext group number should be different with the other extension number

### 3.21.2 Add members in Ext. group

**Format:** 3 9 0 #

**Description:** to delete all extension members in the first group.

**Format:** 3 9 0 N<sub>1</sub> N<sub>2</sub> ... N<sub>R</sub> \* N<sub>S</sub> .. N<sub>T</sub> #

**Explanation:** N<sub>1</sub>, N<sub>2</sub>, N<sub>R</sub>, N<sub>S</sub>, N<sub>T</sub>: the Ext. port No(N= 1-8 means ext 601-608)

**Description:** In the first group join the Ext.N<sub>1</sub>, Ext.N<sub>2</sub>...Ext.N<sub>T</sub>, and from Ext. N<sub>R</sub> to Ext.N<sub>S</sub> is in sequence member.

**Example:** Add Ext.601, Ext.602, Ext.605 ...to Ext.608(include Ext.608) in sequence as members of the first group, then input 390 1 2 5 \* 8 #.

After by this setting, when you dial the group number, Ext.601, Ext.602, Ext.605 ...Ext.608 will ringing at the same time.

**Format:** 3 9 1 #

**Description:** to delete all extension members in the second group.

**Format:** 3 9 1 N<sub>1</sub> N<sub>2</sub> ... N<sub>R</sub> \* N<sub>S</sub> .. N<sub>T</sub> #

**Description:** In the second group add Ext.N<sub>1</sub>, Ext.N<sub>2</sub>...Ext.N<sub>T</sub>, and from Ext.N<sub>R</sub> to Ext.N<sub>S</sub> is in sequence member.

### 3.21.3 Set the Ext. Group work mode

**Format:** 1 6 8 #

**Description:** Set the Ext. group in meeting mode.

**Explanation:** when Ext. group is in meeting mode; If some extension call this group, all the members in this group will ring simultaneously, each extension can pick up the handset to talk with the caller, while the other extension keep ringing. This is also a conference function.

**Instruction:** 1 6 9 #

**Description:** Set the Ext group in normal call mode.

**Explanation:** when Ext group is in normal call mode;If call this group, all the members in this group will ring simultaneously, each extension can pick up the handset to talk with the caller, if any extension answer the call, the other extension will stop ringing.

◆ Default setting is normal call mode.

## Chap 4 Operating Instruction

### 4.1 Day/Night Work Mode Setting

#### 4.1.1 Manual Mode Setting

In manual mode, you can input the following command:

**Format:** # 2 0# Set the system in day work mode.

# 2 1# Set the system in night work mode.



- On default setting, system is in day work mode.
- This setting can be only performed by programming extension (Ext.601, 602, 603, 604), no need in programming status.
- If Ext. is in direct-dialing-out mode, you need to dial \*#20# or \*#21#.

#### 4.1.2 Automatic Mode Setting(Optional only for higher version MS+ series)

**Format:** # 2 2 # Set day/night in auto mode (Same as 040# in programming mode).

# 2 3# Set day/night in manual mode(Same as 041# in programming mode).

**This setting can be only performed by programming extension (Ext.601, 602, 603, 604), no need to enter in programming status.**

**NOTE:**

- ◆ There are two ways to switch Day/Night mode, Manual mode and Auto mode. Auto mode is optional function.
- ◆ In Manual mode, you need to switch Day/Night mode through setting manually, that means every day you must set manually if you want switch Day/Night mode. The system will be in Day mode (or Night mode)always if you don't set manually.
- ◆ In Auto mode, the system will switch between the day and night mode automatically according to the start and end time you set.
- ◆ In Auto mode, the system also will switch between the day and night mode automatically according to the weekend mode you set.

### 4.2 Set & Clear other Ext. Call forward through Programming Extensions

You can set other Ext. call forwarding through Programming Extensions

**Format:**

#26Nabcd: Set No.N Ext. always forward incoming call automatically to Ext.abcd

# 2 6 N #: Clear always forward setting for No.N Ext.

# 2 6 #: Clear always forward setting for all Ext.

# 2 7 N abcd: Set No.N Ext. forward incoming call to Ext.abcd when No.N Ext. is busy or no answer after 30 seconds( call forward time, refer to 3.19.3)

- # 2 7 N #: Clear busy(or no answer)forward setting for No.N Ext.
- # 2 7 #: Clear busy (or no answer) forward setting for all Ext.
- # 2 5 #: Clear any call forward setting for all Ext no matter always forwarding setting or busy(no answer).

**Explanation:** “abcd” is the Ext number to be forwarded, abcd=601–608(default number) N: Ext. port No ,N=1-8 (N=1 means Ext.601... N=8 means Ext.608)

## 4.3 Outgoing Call

The system has 5 dial out mode

### 4.3.1 Outgoing Call Dial 9 at first (or Dial Directly)

**Format:** Pick up the handset and dial 9 at first after hear internal dial tone, then dial the desired number after hear the C.O line dial tone.

**Description:** When Ext is in indirect-Dialing-Out mode, you will hear internal dial tone after pick up the handset, dial 9 then you access the C.O. line, you can dial the number after hear C.O line dial tone.

**Example:** You want to call the external number 80129876 in indirect-Dialing-Out mode



● You need to dial 9 within 15 seconds after hear internal dial tone.

● If Ext. is in direct-Dialing-Out mode, you can pick up the handset and dial number directly after hear C.O. Line dial tone. In this situation you can redial the last dialed number.

### 4.3.2 Outgoing Call by Accessing C.O Line (except for 108)

**Format:** # 1 M (Indirect-Dialing-Out mode, refer chap 3).

**Explanation:** M: C.O. line port number(M = 1 -3)

**Description:** You can choose certain C.O line to make outgoing call.

**Example:** In indirect-Dialing-Out mode, you need to dial external number by accessing C.O. line 3

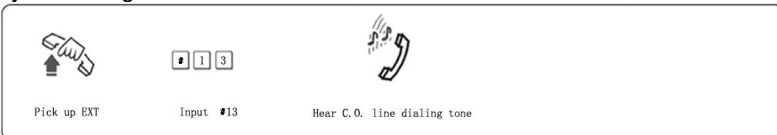

- If the Ext is at Direct-Dialing-Out mode, you should input: \* # 1M.



### 4.3.3 Automatically Call back when CO line is busy

**Format:** # 0 then hang up.

**Description:** in indirect-Dialing-Out mode, if the CO line you are accessing is busy, you can press #0 then hang up, once this CO line is released, system will auto call back your extension.

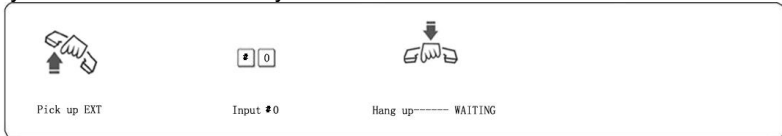

### 4.3.4 Outgoing Call Transfer (Secretary Function)

**Format:** Flash hook (or press the FLASH button) then dial Ext. number

**Description:** This function let you make an outgoing call from one Ext then divert the call to another extension

**Example:** Ext 602 make an outgoing call then need to transfer the call to Ext.606. He can flash hook ( or pressing the FLASH ) and dial 608.

- ◆ 1.Only after 5 seconds(delay time refer 3.2.5)when you dial the last number, you can make the outgoing transfer, otherwise when you flash the hook, the call will be cut off.
- ◆ 2.You need to input the Ext number within 10 seconds after flash hook(or press FLASH button) and hear internal dial tone, otherwise you have to flash hook again to access CO line .

## 4.4 Intercom Call

### 4.4.1 Intercom Call in Indirect-Dialing-Out Mode.

**Format:** If Ext. is in Direct-Dialing-Out mode, pick up handset and dial 9 at first after hear internal dial tone, then Dial the Ext. number directly.

**Example:** Call the Ext.608

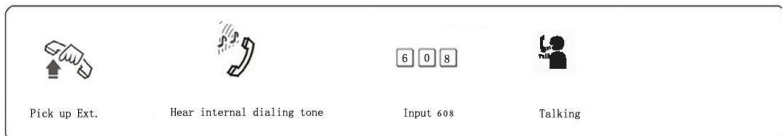

 Intercom call is free of charge. Intercom ringing time can be set(refer 3.19.1)

#### 4.4.2 Intercom Call in Direct-Dialing-Out Mode

**Format:** \* + Ext number

**Example:** Call Ext.608, then you should input \* 608

### 4.5 Answer call

#### 4.5.1 Answer Call in Operator Work Mode

When C.O line incoming arrives, if system is in operator work mode, the operator ringing extension will ring, when you pick up the handset, you can talk with the caller directly. On the default setting, Ext.601 and Ext.602 are operator ringing extension.

#### 4.5.2 Answer Call in Auto-attendant Work Mode

The system is built in three section of OGM message(20s as standard), caller will hear the message in follows situations:

- A.** when external caller call the C.O. line
- B.** when the extension dialed is busy
- C.** when the extension no answer.

Before you use auto-attendant function, you must follow below step:

1. Set the CO.line in auto-attendant work mode (Refer 3.5);
2. Enable auto-attendant in day/night mode(Refer 3.4.1);
3. Setting the OGM section mode;then Record the OGM and Review the OGM (Refer 3.6).
4. Setting system day/night mode.(refer 3.4 or 4.1,optional)
5. Enable\disable OGM fast dialing function(refer 3.5.5).



- You can set different DISA mode.

- When the system enable OGM fast dialing function,you can dial

Dial 1 to call ext. 601、 Dial 2 to call ext. 602,... dial 8 to 608, dial 0 to operator(refer 3.5.5).

#### 4.5.3 Call Pick Up

##### Operation1:

**Format:** # 9 (Indirect-Dialing-Out mode)

**Description:** Allow you to answer an incoming call (direct or transferred) which is ringing on other extension.

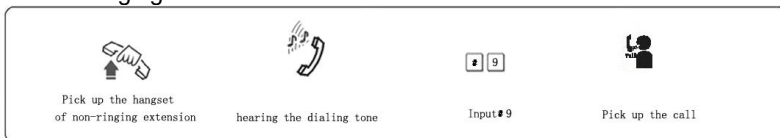

- If the Ext is in Direct-Dialing-Out mode, you should input: \* # 9.

- Internal call can be also picked up.

##### Operation2:

**Format:** # 3 + Ext . number (Indirect-Dialing-Out mode)

**Description:** Allow you to answer an incoming call (direct or transferred) which is ringing on another extension.

 • If Ext is in Direct-Dialing-Out mode, you should dial \* # 3 + Ext .number

## 4.6 C.O. Line Reservation (except 108)

**Format:** Flash hook and ## (Reservation)  
\* # 9 (Restore)

**Description:** Extension N is talking with C.O. line A and at this time incoming call from C.O line B arrives, Extension N can flash hook and press ## to hold A(now A is hearing music on hold). At this moment, Extension N can also make call pick up(input # 9), call transfer, dialing out etc...if Extension N need to restore the connection with C.O. line, just input \* # 9.

- ◆ On default setting, the holding duration time is 120 second.
- ◆ One extension can hold several call.

## 4.7 Call Transfer(External Call)

### 4.7.1 Call transfer to another Extension

**Format:** Flash hook (or press the FLASH button) then dial the Ext. number.

**Description:** 1. Allow you to transfer an incoming call to another Ext. 2.The Flash time can be set. 3.In the process of the transfer, the C.O. line will hear music on hold.

**Example:** Ext.605 is talking with C.O. line and need to transfer the call to Ext.607.Then Ext .605 can transfer the incoming call to Ext .607 by flashing hook (or pressing the FLASH ) and dialing 607.

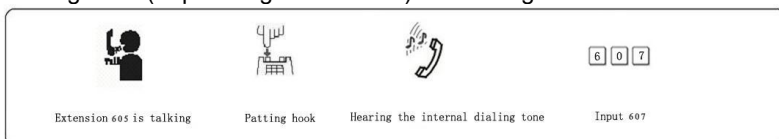

 ◆ There maybe following 8 cases after a call is transferred from Ext. A to Ext. B:

- A does not hang up after B pick up handset .Then communication between A and B is established while C.O line is on hold (music on hold). Whoever hang up (A or B), system will transfer C.O line to the other.

- A does not hang up and B does not answer A within 25 seconds. Then A will restore the connection with CO. line, and B will stop ringing.

- A hang up and B answer the call; B will talk with C.O line.

- A hang up and B does not answer the call within 25 seconds, the call will be back to ring A, if A never picks up the call in 30 seconds or A is busy, the C.O line will be cut off.

- After A flash hook then hear the error message, that means the system is busy, A can proceed to flash hook (or press the FLASH button) until the error message is disappear.

- A make invalid operation or B is busy, After a continuous beep tone(du-du-du), A can repeat the operation.
- A hang up and B does not pick up. A pick up again and press: # 9 (If the Ext is at Direct-Dialing-Out mode, you should input: \* # 9), then A will restore the connection with C.O. line.
- The EXT. which transfer the call (flash hook), then the C.O line will be on hold status until dial the right Ext. number or flash hook again to access CO line.

#### 4.7.2 Call Transfer to Ext.Group

**Format:** Flash hook (or press the FLASH button) then dial Ext. Group number.  
**Description:** 1. Allow you to transfer an incoming call to Ext. Group, after transfer is succeed ,the members of the Ext. Group will ring together. When any one of the ringing Ext. pick up, others will stop ringing.

### 4.8 Call switch (call pick up during conversation) (except 108)

When extension is talking with C.O line, another Ext or a door phone, or another C.O line call in, the first Ext will hear prompt beep tone(the beep for door phone call and C.O line call is different). Then you can:

**Operation1:** Flash hook (or press the FLASH button), then you will hear dial tone, press “# 9” to switch another C.O line, also you can switch to receive the call from door phone. The first conversation now is on hold(for CO.line talking), for the conversion with door phone will be ended , when you talk with the second call, you can also flash hook and press # 9 to retrieve the first holding call.

### 4.9 Secretary Function(Outgoing Call Transfer Function)

**Format:** Flash hook then dial the Ext number  
**Description:** This function allow one extension to make an outgoing call and then divert it to another Ext.  
**Example:** Ext .605 make an outgoing call then forward the call to Ext. 601.

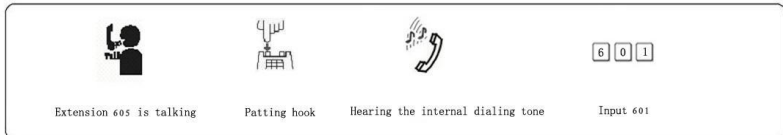

You should input the Ext. number within 5 seconds after flash hook (or press FLASH button ) and hear internal dial tone, otherwise you will come back to the C.O. line again.

## 4.10 Three Way Conference (1 C.O Line and 2 Ext)

**Format:** Flash hook (or press FLASH button) dial \* + Ext. number

**Description:** Allow you to add a third party to a two-party conversation and make a three-party conference. You can have only two Ext. with one C.O. line.

**Example:** Ext. 605 is talking with C.O. line caller and then he need to add Ext.607 in the call.

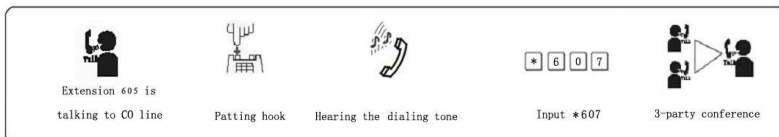

There maybe following 2 case after a call is transferred from A to B.

a. A does not on hook and B off hook. Then communication amount A, B and C.O. line is established, whoever on hook (A or B), the system will transfer C.O line call to another one.

b. A does not on hook, if B does not answer within 25 seconds, then A will restore to access C.O. line, and B stop ringing.

## 4.11 Call Forward

### 4.11.1 Call Forward Always

**Format:** # 81 abcd

**Explanation:** "abcd" is extension number to be forwarding.

**Description:** Allow one Ext to forward incoming call automatically to another Ext. This is also one of Manager/Secretary function. Allow manager's Ext. to forward incoming call automatically to Secretary's Ext abcd.

**Example:** Ext. 605 need to forward all incoming call to 607 automatically

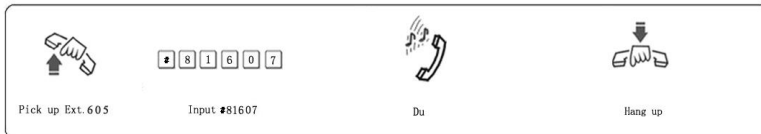

**Format:** # 81\* ABCDEF#

**Explanation:** ABCDEF is external number(landline or mobile number)  
The number is 1-16 digit, This is in Indirect-Dialing-Out mode.

**Description:** Allow one extension to forward incoming call automatically to another external number ABCDEF. Including auto call forward to mobile phone

**Example:** Ext.605 need to forward all incoming to mobile number 1367409 automatically.



**Format:** # 81 #

**Description:** Clear call forward always

 ● In Direct-Dialing-Out mode, you should set with \*#81abcd(or \*#81ABCDE#) and clear with\*# 81#.

- Before setting, use #81# to clear other settings.
- If you set# 81 \* ABCDEF #, then the setting # 81abcd is disabled.

#### 4.11.2 Call Forward When Ext is busy or no answer

Before you can set this function, please use #81# and #82# (or #80)to clear all the setting of call forward.

**Format:** # 82 abcd

**Explanation:** abcd" is extension number to be forwarding

**Description:** If one Ext is busy or no answer after 20 seconds(refer 3.19.3), the incoming call will be forwarded to another Ext.

**Format:** # 82 \* ABCDEF #

**Explanation:** ABCDEF is external number(landline or mobile number)  
The number is 1-16 digit, This is in Indirect-Dialing-Out mode.

**Description:** If one Ext is busy or no answer after 20 seconds (refer 3.19.3), the incoming call will be forwarded to the another external numberABCDEF.

**Example:** When Ext.605 is busy or no answer, and incoming need to be forwarded to external number 1367409, the setting is like this:pick up Ext.605, input #82\*1367409#, after hear a beep tone, hang up.

**Format:** # 82 #

**Description:** Clear call forward(busy/no answer)

**Note:** ◆ In Direct-Dialing-Out mode, you should set with \* # 82 abcd (or #82\*ABCDEF#) and clear with \* # 82#.

- ◆ If you set # 82\*ABCDEF#, then the setting # 82abcd is disabled.

#### 4.11.3 Set Call Forward(to external number)talking time

**Format:** # 84TT

**Description:** Set the talking time for Call forward(to external number) (TT = 01-99, units:10 seconds)

On default setting,TT=09, that is 90s(80s for talking,10s for reminder)

Note: Each extension has different talking time.

**Example:**When set extension A call forward to external number M

1. When External caller K call extension A, system will forward the call(always/ busy/no answer)to external number M, after connected, 2 C.O line user can talk. When the talking time is beyond the setting time

(#84TT,default is 80s) ,then the system will send reminder tone till 10s, at the same time each external user can press # to proceed the conversation till another 80s. If no operation,the call will be cut off. Meanwhile, any CO line user can press \* to end with the call.

II. when C.O line user K is talking with external number M, Extension A can pick up the call by #9 to talk with two external users, talking time is not restricted ,when Extension hang up, the call will be cut off.

◆ **Note:** If Ext is in Direct-Dialing-Out mode, you should input: \* # 84TT.

## 4.12 Ext. Number Query

**Format:** # 61

**Description:** During the installation and testing to the system, it is very convenient to know the Ext number. The system use beep tone (“du”) to indicate the number.

**Example:** After input # 61 on Ext. 603 you will hear 6 continuous beep tone(“du-du-du-du-du-du”)at first, after 1.5 seconds, you will hear 10 continuous beep tone, at last you may hear another 3 continuous “du” , that mean the Ext number is 603.



- 10 continuous beep tone stands for “0”.
- If Ext is in Direct-Dialing-Out mode, you should input \*# 61.

### 4.12.1 Display Ext number on Caller ID phone

**Format:** # 62

**Example:** Pick-up Ext.605(caller ID phone), Input # 62, after hear a beep tone, then hang up, the extension will ring one second ,and you can see the port number + Ext number on telephone: 05 605.



- If Ext is in Direct-Dialing-Out mode, you should input \* # 62.

## 4.13 Priority Access(Call Monitor)

**Format:** # 7 M

**Explanation:** M: the C.O. line port number. M = 1 - 3

**Description:** This feature ensures director or owner of a company monitor the call for some C.O line.

**Example:** Priority access to C.O. line 3.

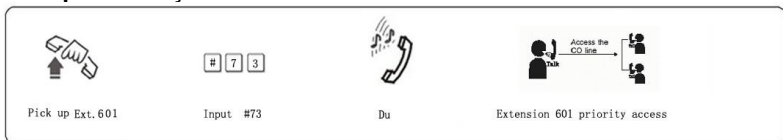

- Only Ext.601 has priority access
- If the Ext is at Direct-Dialing-Out mode, you should input: \* # 7 M.
- The monitor is responsible for the legal issues resulting from the

operation.

## 4.14 Call Operator Directly

**Format:** 1520# Any extension can call operator directly by dialing 0

**Format:** 1521# Disable extension call operator directly by dialing 0

 If in Direct-Dialing-Out mode, Ext should dial \* 0.

## 4.15 Internal Hotline Function

**Format:** 883# Enable internal hotline function for all extension

**Format:** 883N# Enable internal hotline function for No.N extension

**Format:** 884# Disable internal hotline function for all extension

**Format:** 884N# Disable internal hotline function for No.N extension

**Format:** 189TT# Set waiting dialing time in hotline status, that is when hotline extension is picked up, within the time TT, if no any dialing, system will call operator directly. Default TT=0.

 • After set internal hotline function, any extension when picked up, will call operator directly.

- Above setting should be performed in programming status.

## 4.16 Do Not Disturb(DND)

### 4.16.1 Set Do Not Disturb(DND)

**Format:** # 83

**Description:** If DND is set, then extension will not ring.

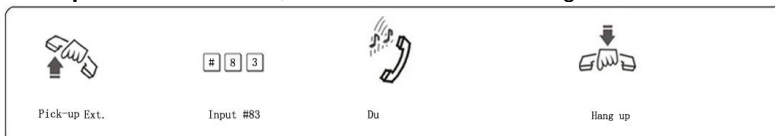

 If Ext is in Direct-Dialing-Out mode, you should input: \*# 83

### 4.16.2 Clear Do Not Disturb(DND)

**Format:** Pick-up the handset

**Description:** To cancel DND function, you just pick up the handset.

## 4.17 Clear Extension Function Setting

**Format:** # 8 0

**Description:** This command will clear all function that extension was set, such as DND/Call divert/Call forward/C.O line booking etc. This command has no influence to other extension.

 If the Ext is in Direct-Dialing-Out mode, you should input \* # 80.



## 4.18 Call All Extension(Group Call)

**Format:** #88

**Description:** one extension can dial #88, then all other extension will ring simultaneously, if any extension is picked up, can talk with the calling extension, while the other extension keep ringing.



If Ext is in Direct-Dialing-Out mode, you should input: \*# 88.

# Chap 5 Maintenance&Troubleshooting

## 5.1 Outgoing calls can't be made

- 1). C.O. line is set to special Extension;
- 2). Extension hang up improperly;
- 3). CPU and internal data is disorder caused by unstable power.
- 4). Call restriction class is 6.

## 5.2 Outside calls can't dial in

- 1). The conjunction of C.O. line loose;
- 2). C.O. line was connected to other equipment;
- 3). No message recording at auto-operator mode.

## 5.3 Intercom can't be made

- 1). Extension hang up improperly;
- 2). Extension number wrong.

## Chap 6 Glossaries

BREAKDOWN	CAUSE	SOLUTION
Running light malfunction	Power off	Check the power socket and Power supply
No sound from extension	Disconnected wiring or malfunction of telephone.	Reconnect the wiring or try to remove the telephone's failure
Cacophony	Bad connection	Screw down the joint
	The distributing of line is not reasonable	Leave telephone from the disturbing source
Bad tone	Mix using of non-standard telephones	Use the standard telephones
No incoming	Devoid function of incoming telephone display	Write application to telecommunication office
telephone display	Wrong setting of No-disturbing and it status.	Rescind the No-disturbing and set incoming telephone display
Dial-out malfunction	Exterior line disconnected	Connect to the exterior line
	Exterior line is not connected well	Check whether the line is connected well
Limited calling time	Time limited	Rescind the limit
Cannot program the telephone	Wrong coding	Check the programming extension and use the right code
Others	Others	Refer to professional

- ◆ **Programming extension:** Extension No.601, 602, 603, 604
- ◆ **EFGH:** 4 digits of programming password
- ◆ **N:** Series number of the extensions (1-8 with corresponding input ports 1-8) (one digits)
- ◆ **abcd:** Number of the extension(1-8999,except for the digits with the first digit of 0 or 9,outward code of special trunk line, in equal length)is accordance with N.
- ◆ **M:** Series number of the exterior line (No.1-3 with corresponding input ports of Line 1- 3,108---M=1; 206---M=1-2; 208---M=1-2; 308---M=1-3)
- ◆ **P:** Licensed Group Number (01-16)
- ◆ **Q:** First-digit restrict group number (01-16)
- ◆ **ABCD:** Licensed or restricted number of first 1-4 digits, end for #
- ◆ **L:** Service grade , grade 0-6
- ◆ **TT:** Time in minute for call duration control, ranges from (01 to 99) Flash time class.

## Chap 7 Default Settings

- C.O. line: 108/206/208/308 are in Disabled status.
- Operating mode: All C.O. line in Operator mode,
- Dial out mode: 108/206/208/308 are in Indirect-Dialing-Out mode, dial "9" for outgoing call
- Original EXT number: 601 to 608 and Operator: Ext. 602
- Add two digits 00 in intercom CID number
- Day/night mode Ext access C.O. line: all extensions
- Day/night operator mode Ringing Ext.: Ext.601 and Ext.602 ring.
- Day/night mode Extension service class assignment: 1
- Time Restriction: No
- Flash time: 1.0s
- Outgoing Exts. Assign to Certain C.O. lines: No
- Restrict Item A / Item B: No setting
- Special Calling-out Number: No setting
- The first Ext.Group number:20  
The second Ext.Group number:21
- The member of the first Ext.Group: 601-608  
The member of the second Ext.Group: No
- Auto-attendant Mode no Dial/Answer Process: call disconnected.
- Day/night mode:manual switching,day mode.
- Ext. Groups working mode: normal calling mode
- Fax Detecting function is Disabled

# Chap 8 System Programming & Operation Instruction

## 8.1 Index of Basic Operation

	Description	Indirect-Dialing-Out mode Command	Direct-Dialing-Out mode
1	Set to day status in manual mode	# 2 0 #	*# 2 0 #
2	Set to Night status in manual mode	# 2 1 #	*# 2 1 #
3	Outward Dialing	9 + desired number	desired number
4	Outward Dialing by a Exclusive Line	# 1 M	*# 1 M
5	Outward Redialing	# 5	*# 5
6	Intercom calling extension	Ext. number	*+Ext . number
7	Intercom calling Exts.Group	Exts. Group number	* + Exts.Group number
8	Call Transfer	Pat hook + Ext number(or Exts.Group number)	
9	Secretary Function	Pat hook + Ext number	
10	3-Party Conference Call	Pat hook + * + Ext number	
11	Caller on holding	Pat hook + ##	
12	Call Pickup for certain Ext.	# 3+ Ext number	*# 3 + Ext number
13	Call Pickup for all calling	# 9	*# 9
14	Call switch	Pat hook + # 9	
15	R key(for waiting call function on the same line)	Pat hook + # 8	
16	Call Forwarding Directly	setting: #81 +Ext .number setting: #81+*+External. number	*# 81+Ext. Number *#81+*+External. number
		clear : # 81#	*# 81#
17	Call Forwarding when Ext is busy or nobody available	setting: #82 +Ext. number setting: #82+*+External. number	*# 82+Ext. number *#82+*+External. number
		clear : # 82#	*# 82#
18	Automatically Call back Busy-come on	# 0	*# 0
19	Automatic Reporting of Ext number (voice)	# 61	*# 61
20	Reporting of Ext number for caller ID phone	# 62	*# 62
21	Connect with Operator Directly	0	* 0
22	Priority Access and Monitoring (only Ext.601)	# 7 M	* # 7 M
23	Setting Don't disturb	# 8 3	*#83
24	Call all extensions	#88	*#88
25	Clear extension function setting	#80	*#80

26	Call all extensions( in default setting call EXT.group 1)	#20	*#20
27	Function code & Office code setting	Function code *,office code #	000010#
		Function code #,office code *	000011#

## 8.2 Index of system programming

	Description	Command
1	Enter System Programming Status	(*) # * EFGH
2	Change System Password	09 EFGH#
3	Restore Default Setting	0000 #
4	Enable all C.O. lines	0600 #
5	Disable all C.O. lines	0610 #
6	Enable No. M C.O. line	060M #
7	Disable No. M C.O. line	061M#
8	Set day/night mode to automatically mode	040#
9	Set day/night mode to manual mode	041#
10	Day mode start time	042HHTT#
11	Day mode end time	043HHTT#
12	Using the OGM day & night	0440#
13	Using the OGM in day mode	0441#
14	Using the OGM at night mode	0442#
15	Enable weekend mode function	0480#
16	Disable weekend mode (default setting )	0481#
17	To set from Monday to Sunday as work day	04900#
18	To set week W as work day	0490W#
19	To set from Monday to Sunday as weekend day	04910#
20	To set week W as weekend day	0491W#
21	Set OGM in one section mode	0451#
22	Set OGM in two section mode	0452#
23	Set OGM in three section mode	0453#
24	Set OGM in four section mode	0454#
25	All C.O. lines in Auto-attendant Mode	10 #
26	C.O. line M in Auto-attendant Mode	10 M #
27	All C.O. lines in Operator Mode	11 #
28	C.O. line M in Operator Mode	11 M #
29	To recording one section OGM	1200 #
30	To play and check one section OGM	1300#
31	Monitor Holding Music	14 #
32	Setting Operator	15 N #
33	No dialing in DISA--- C.O. Line disconnected	160 #
34	No dialing in DISA----Transfer to Operator	161 #
35	Any extension can call operator directly by dialing 0	1520#
36	Disable extension call operator directly by dialing 0	1521#
37	Cancel auto-attendant fast dialing function	1546#
38	Set auto-attendant fast dialing function	1547#
39	OGM busy in	Waiting
		1540#

	auto-attendant	Transfer to operator	1541#
40	No dial in auto-attendant	Release C.O. line	160#
		Transfer to operator	161# or 1610#
		Transfer to operator mode ringing extension	1616#
41	System option for transfer to a no answer Ext	Call back the extension	162#
		Don't call back	163#
42	Dialing Extension Busy process in auto-attendant	Line break when busy	165#
		Transfer to operator	1650#
		send prompt tone to the extension	1655#
		transferred to the operator mode ringing extension	1656#
43	No Answer process in auto-attendant	Cut off C.O.Line	166#
		Transfer to operator	1660#
		transferred to the operator mode ringing extension	1666#
44	System CRBT in auto-attendant	Disable CRBT function	167#
		Call the operator directly	1670#
		call the operator mode Ringing Extensions	1676#
45	Power Failure Conservation	Not conservation	170#
		Conservation	171#
46	Set Exts groups in the meeting work mode		168#
47	Set Exts groups in the normal work mode		169#
48	Disable add digits for intercom CID		180 #
49	Add KK in intercom CID number		180 KK #
50	No answer call forwarding time		184TT#
51	Setting duration of switch signal ( for 208 )		185TT#
52	C. O line reservation time		186TT#
53	Direct-Dialing-Out mode for Ext.N		2 N 0 #
54	Indirect-Dialing-Out mode for Ext.N		2N1 #
55	Direct-Dialing-Out mode for all the Exts.		20 #
56	Indirect-Dialing-Out mode for all the Exts		21 #
57	Dial all member in the first Exts. Group		390#
58	Add member in the first Exts.Group		390 N <sub>1</sub> N <sub>2</sub> ... N <sub>R</sub> * N <sub>S</sub> .. N <sub>T</sub> #
59	Del all member in the second Exts. Group		391#
60	Add member in the second Exts.Group		391 N <sub>1</sub> N <sub>2</sub> ... N <sub>R</sub> * N <sub>S</sub> .. N <sub>T</sub> #
61	Enable Exts N ring When No.M C.O line calling( in day mode )		30MN0#
62	Disable Exts N ring When No.M C.O line calling(in day mode)		30MN1#
63	Disable all Exts ring When No.M C.O line calling( in day mode)		30M#
64	Enable Exts N ring When No.M C.O line calling(in night mode)		31MN0#
65	Disable Exts N ring When No.M C.O line calling( in night mode)		31MN1#
66	Disable all Exts ring When No.M C.O line calling(in night mode)		31M#
67	Assign dialing-out class L for certain Ext. N		40NL #
68	Assign dialing-out class L for all Exts		40L #
69	Restrict the Certain Numbers from item A		41 Q ABCD #

70	To cancel the restriction of item A	41 #
71	To clear group Q of restriction item A	41Q#
72	Restrict the Certain Numbers from item B	42 Q ABCD #
73	To cancel the restriction of item B	42 #
74	To clear group Q of restriction item B	42Q#
75	Assign Special Calling-out Numbers	43 P ABCD #
76	To cancel the permission of special calling-out numbers	43 #
77	To cancel group P of special calling-out numbers	43 P #
78	Internal call ringing time	494TT#
79	Call transfer ringing time	496TT#
80	Set the ringing time in round robin mode	499TT#
81	Time Restrict Setting	6N TT #
82	To cancel time restrict	6N00 #
83	assign NO.N EXT. to use C.O.line M in day mode	70MN0#
84	To restrict the NO.N EXT. to use C.O line M in day mode	70MN1#
85	Allow all Exts. to use C.O line M in day mode	70M0#
86	To restrict all Exts. to use C.O line M in day mode	70M1#
87	Assign the No.N Ext. to use t C.O.line M in night mode	71MN0#
88	To restrict the No.N Ext. to use C.O line M in night mode	71MN1#
89	Allow all Exts. to use C.O line M in night mode	71M0#
90	To restrict all Exts. to use C.O line M in night mode	71M1#
91	The Exts number return to the default setting	9000 #
92	To change the first Exts.Group number to new number "abcd"	990abcd#
93	To change the second Exts.Group number to new number "abcd"	991 abcd#
94	To change the Ext.N to new number "abcd"	9Nabcd #

# Appendix I Door-phone Function

## I.1 Connection instruction:

The system can be connected with two door-phone

For 108 view

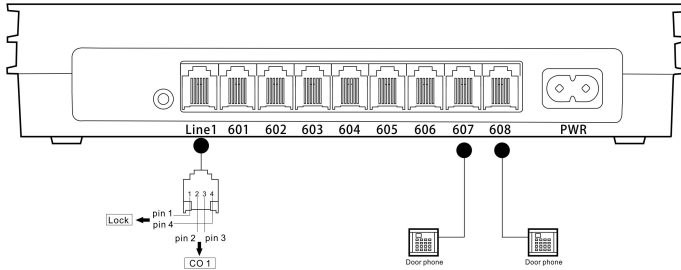

For 206 view

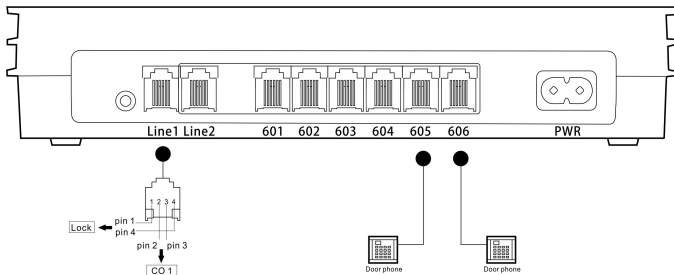

For 208 & 308 view

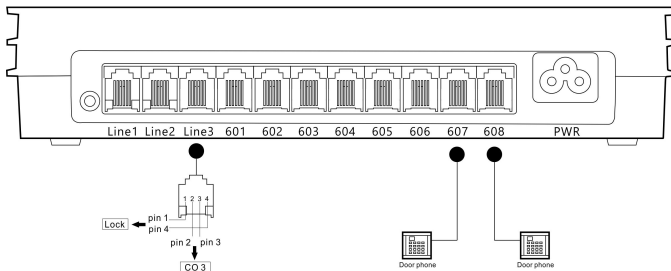

The system provide door opener(door-open switch, connect with the wire of electric lock) interface, and system can defined two extension as door phone.



## I.2 Set Door-phone function

You need to perform the following setting in system programming status by programming extension(Ext.601-604)

### I.2.1 Set the port of Door phone

**Format:** 80N# set the first door phone (N is Ext port number)  
81N# set the second door phone (N is Ext port number)  
8000# clear setting of the first door phone  
8100# clear setting of the second door phone

Default: door phone is not set

### I.2.2 Door phone ringing Extension Setting

**Format:** 8 2 #

**Description:** Clear all extension assigned to door phone.

**Format:** 8 2 N#

**Description:** Set Ext.N as the ringing extension when door phone call in

**NOTE:** ◆ On default setting: Ext.601 & Ext.602 are ringing extension for door phone call.

◆ Maximum 8 extensions can be set as the ringing extension for door phone call.

### I.2.3 Set Duration of switch Signal

**Format :** 1 8 5 TT#

**Explanation:** TT = 01-99 opener action time is TT\*0.1s

**Description:** Set the door opener action time (the closing time for the relay of door opener).

**Description:** If you press \* 1 to open the door, the unlock signal will be kept in a few seconds. You can set the duration of unlock signal to match with electric lock.

On default setting, TT=4, means 0.4s.

## I.3 Operating Instruction

**Operation1:** Press the call button on door phone and press\*1 to open the door lock.

**Description:** when visitor press the call button on door-phone, The door phone ringing extension will ring, at this moment the door phone will be on the status of music on hold (if nobody answer after 25s, system will send a busy tone to door phone), you pick up the ringing extension to talk with the visitor.

During talking with the door phone caller, Extension input \*1 to open the door lock.

 • Any extension can pick up the call and open the door when visitor press door phone

• When visitor press the door phone, If the ringing extension assigned to the door phone are all busy at this moment, the system will send a busy tone to door phone, in the mean time, the extensions will hear a continuous beep tone as reminder.

• System has 3 different ringing tone for different call:

- one for the intercom call
- one for the door phone call
- one for the C.O.line incoming call

**Operation2** : directly open the door

Pick-up + # 19 to open the door lock directly.

◆ **Note**: If the Ext is in Direct-Dialing-Out mode, you should input: \* # 19.

## Appendix II Least Cost Routing (LCR) Setting

### II.1 Instruction for LCR

- The system has two mode for LCR:
  - Manual mode: when user dial out, system will access the least-cost routing line according to the outgoing code dialed.
  - Auto mode: when user dial out, system will access the least-cost routing according to the routing number which set in system(user no need to dial any special access-code, the system will select routing intelligently.

- System define the trunk line in two types: (trunk line=C.O. line)
  - Normal trunk line (C.O. line): normal telecom trunk line
  - Special trunk line: it means the communications network of some other provider, like VOIP / GSM / CDMA.....etc, which can offer the cheaper rate for some international call, some domestic-long-distance-call.

### II.2 Programming setting

The following setting should be performed in programming status:

**Format:** 0700#

**Description:** Initialize LCR setting, on default setting, Routing function is disabled, the system treat all C.O. line as normal trunk line.

**Format:** 0710#

**Description:** Enable auto LCR function

**Format:** 0711#

**Description:** Disable auto LCR function

**Format:** 0720#

**Description:** Enable manual LCR function

**Format:** 0721#

**Description:** Disable manual LCR function

**Format:** 0730#

**Description:** System will access normal trunk line if special trunk line is busy.

**Format:** 0731#

**Description:** Restrict system access normal trunk line if special trunk line is busy.

**Format:** 0732#

**Description:** System will access special trunk line if normal trunk line is busy.

**Format:** 0733#

**Description:** Restrict system access special trunk line if normal trunk line is busy.

**Format:** 0740#

**Description:** allow normal trunk line available for outgoing & incoming.

**Format:** 0741#

**Description:** Don't allow normal trunk line available for outgoing.

**Format:** 0750#

**Description:** allow special trunk line available for outgoing & incoming

**Format:** 0751#

**Description:** Don't allow special trunk line available for outgoing.

### **Set trunk line in Normal trunk line / Special trunk line**

**Format:** 0760#

**Description:** Set all trunk line as Normal trunk line

**Format:** 076M#

**Description:** Set NO.M trunk line as Normal trunk line (M=1-3)

**Format:** 0770#

**Description:** Set all trunk lines as the special trunk line

**Format:** 077M#

**Description:** Set NO.M trunk line as special trunk line(M=1-3).

### **Set outgoing access-code for Special trunk line**

**Format:** 078K#

**Description:** In Manual LCR mode, set outgoing code K to access special trunk line.



- K=1, 2.....8 (K can't be outgoing code 9 or 0)
- K can't be the same as the first digit of extension number

### **Set routing number for special trunk line (In Auto LCR mode)**

**Format:** 08#

**Description:** Clear all routing number for special trunk line. We recommend user to use this format before set auto LCR function.

**Format:** 08QABCD#

**Description:** Set prefix starting with ABCDEFGH for auto LCR to Special trunk line

**Format:** 08Q#

**Description:** Clear certain number of group Q for auto LCR to Special trunk line



Remark:

- ABCD is the initial digits of the outgoing number for routing to Special trunk line, ABCD can be 1-4 digits, for example: it can be: 0,52,139,1790...etc.

- Q is the group series number from 01 to 16, Q is 2 digits.

### II.3 Operating instruction

- ◆ Enable/Disable the CO.line
- ◆ Set trunk lines to Normal trunk line / Special trunk line
- ◆ Enable Routing function & Setting Auto LCR or Manual LCR mode
- ◆ In manual LCR mode,set outgoing access-code (K) for special trunk
- ◆ In Auto LCR mode, set certain number for routing to Special Trunk line then operating as follow:

#### In Manual LCR mode

If the extension is in indirect dialing-out mode,

Use the Normal trunk line: Pick up the handset → Dialing 9 out  
→ the calling number

Use the Special trunk line: Pick up the handset → Dialing K out  
→ the calling number

**If the extension is in direct dialing-out mode, Pls note: you must input\* to enter the intercom status**

#### In Auto LCR mode

You can dial out the same as before. If the number you dialed with the prefix you set, then the system will auto access the special trunk line. Otherwise the system will access the normal trunk line.

## Appendix III Auto Add Prefix number dialing

Through this function,when extension make an outgoing call, then system will add prefix number automatically in front of the number dialed. You can set two groups prefix number, each number correspond to any C.O. Lines

### III.1 Programming setting

The following format should be performed in programming status:

### III.2 Enable/Disable prefix number add Dialing function

**Format:** 8400#    disable prefix add dialing function for all C.O. line  
84N#    disable prefix add dialing function for No. N Ext  
8500#    enable prefix add dialing function for all extension.  
85N#    enable prefix add dialing function for No. N Ext  
8803#    all outgoing call use added prefix number  
8804#    enable special C.O. line (trunk line) prefix add dialing  
function, only add prefix number when call special trunk line.  
8800#    cancel 8803# and 8804# setting functions.

### III.3 Prefix Number Setting

**Format:** 83ABCD + off-hook

**Description:** ABCD --- prefix number, the longest number is 60 digits, 0...9, # is the dialed number, \* mean pause, one \* mean pause 1s, can use more \* to add waiting time.

**Example:** If prefix number is 17909, input 8317909+off-hook

### III.4 Prefix Number Dialing

◆ As per normal dialing mode(direct dialing-out mode/indirect dialing-out mode both ok)to dial the number, system will auto add prefix number.

## Appendix IV Abbreviated-dialing (Memory dialing)

This function allow Extension to make an outgoing call with only dialing two digits series No.(one serial number indicate a string of real phone number).

### IV.1 Programming setting

The following format should be performed in programming status:

**Format :** 46 #    to clear all Abbreviated-Dialing Number.

46K#    to clear the Abbreviated-Dialing Number of Group K

46KABCD...#    to set the Abbreviated-Dialing Number of Group K

**Explanation:**

◆ K is the group number, K =01-96. You can set at most 96 groups.

- ◆ ABCD... is abbreviated-dialing number. The longest numbers can be 16 digits.

## IV.2 Operating instruction

For normal phone :

**Format:** Pick up and dial #70 + the group number (01-96)

**Example:** you set number 86228930 as the first group abbreviated-Dialing number: Pick up Ext.601, enter into programming state (\*\*0000 ) and hear beep tone, then dial 46 # (the first time setting it's better input this instruction to clear all data), after hear a beep tone then input 46 0186228930. After this setting, you can pick up one extension and dial #70 01, system will access available C.O line and call 86228930 automatically .

## Appendix V Extension Dynamic Lock

Each extension can set itself lock password, the dialing level is 6 (can only dial intercom call)

### V.1 Set the password of dynamic lock

**Format:** off hook extension + input (\*)#5\*abcd

ABCD (notes: abcd is default password, is 0000, ABCD is new password, if typing mistake, will hear busy tone )

### V.2 Locking setting

**Format:** off hook extension + input (\*)#5#ABCD\*,

After succeed you will hear a verification tone, this extension level turn 6 (can only dial intercom call, no matter day/night mode

### V.3 Unlocking setting

**Format:** off hook extension + input (\*) #5#ABCD#,

After succeed you will hear a verification tone, this extension level turn back to original level

### V.4 Initialization / Clear the password

**Format:** 50000# the entire extension password returns to default 0000  
500NN# to clear the Extension NN password (NN is extension serial number, NN =01-16)