

Specification

Products Name: 30W Blue Sky Series Floodlight

Model No.: ZGE-TGD224WB184B-30LF

Product Code: 16124022

Document Code: ZH-WI-TD-SPEC-

Edition A/1

Department: R&D Certer

Changed records of issued documents

Issued time	Version	Changed content	Implementer
2014-9-12	A/0	First Issuing	Liang Jianquan /Gao He
2014-9-25	A/1	Packing specification parameter change	Gao He

Documents distributed to department: department of technology、 product department、 quality control department、 engineering department、 internal sales department、 International Trade Department

Edited:

Verify:

Approval:

Document number:		Products Name	30W Blue Sky series floodlight	Formulating time: 2014-9-12		
Edition	Page number			Amending date:		
A/0	1/8	Model	ZGE-TGD224WB184B-30LF	Approve	Audit	Formulate

一、 Purpose: Definite technical standard of LED light,direct LED examination

二、 Basic specifications of product:

- A、 Appearance as right image:
- B、 Light boundary dimension: 224*190*101mm
- C、 Lamp net weigh: 1290g±20g
- D、 Lamp color: Bright silver/Satin black
- E、 Material: lampshade-glass; lamp body - Alu.ADC12; reflector - Alu.1060;
- F、 LED Chip: 1 PCS COB; 15 series 2 parallel, 33mil.
- G、 Power wire: conductor $\geq 1.0\text{mm}^2$; wire length: $\geq 0.3\text{m}$; tail end: copper-clad
- H、 Power driving model: IC constant current type; driving IP grade: IP65
- I、 IP grade: IP65; electrical shock protection grade:I Class;
- J、 Environment temperature: working $-20^{\circ}\text{C}\sim +45^{\circ}\text{C}$; storage $-30^{\circ}\text{C}\sim +60^{\circ}\text{C}$;
- K、 Environment humidity: working- 10%~75%; storage- 10%~90%
- L、 Lamp head: N/A
- M、 Others: not dimmable, non-dimmable lamps

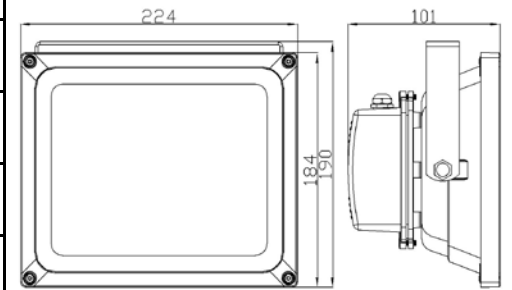

三、 Electric parameter:

Test condition:light for 15 mins under nominal voltage input and $25^{\circ}\text{C}\pm 1^{\circ}$ working environment

Item name	Unit	Minimum value	Typical value	Maximum value	Remarks
Input Voltage	V	AC100	AC220	AC240	
Input Current	A	0.3	0.14	0.1	
Lamp power	W	30W $\pm 10\%$			
Power factor	PF	≥ 0.9			
Light power	W	30W $\pm 10\%$			
Frequency	Hz	47	50	63	
Output	DC36-48V; 600mA $\pm 5\%$				
Power conversion efficiency	%	85MIN.			

Document number:		Products Name	30W Blue Sky series floodlight	Formulating time: 2014-9-12		
Edition	Page number			Amending date:		
A/0	2/8	Model	ZGE-TGD224WB184B-30LF	Approve	Audit	Formulate

四、Optical parameter requirement:

Test condition:light for 15 mins under 220V AC input and 25°C±1°working environment

Item name	Unit	Minimum value	Typical value	Maximum value	Remarks
Color temperature	K	/	/	/	
		/	/	/	
		5800	6150	6500	Pure White
Color rendering index(CR)	Ra	/	/	/	
		/	/	/	
			≥70		Pure White
Luminous Flux	lm	/	/	/	
		/	/	/	
			≥2160		Pure White
Lighting effect	lm/W	/	/	/	
		/	/	/	
			≥80		Pure White
Beam angle	°	110	115	120	
Chromaticity	SDCM	<10			

五、Reliability requirements:

Item name	Standard specification
Lumen maintenance	Lumen maintenance is not lower than 92% after lighting for 3000h,and not lower than 88% after lighting for 6000H; and not lower than 70% after lighting for 70% of lifespan
Working life	Under nominal voltage input, working life is forced not lower than 25000h in 25°C±1°C
Guarantee period	2 years
IP grade	Must meet the test requirements of IEC or GB to the IP rating
Durability test	Test cycle should be 10 cycles,circuit should normal operate during 10 cycles.1 cycle is 24h,mains input on lamps during the begining 21h,then cut down the input in the last 3h.Testing voltage:nominal voltage X 1.10 ± 0.015,forbiding below case during test-- 1.any part could not lose efficacy; 2.lamp could not be unsafe; 3.No damaging track system; 4.writing label should be clear; 5.No crazing,burn,shape changed and so on.
Low temperature and low pressure	placing for 3 hours in -20°C temperature,then start it with 100V,light normally.(not IEC or GB test standard, it's enterprise internal test regulations)

Document number:		Products Name	30W Blue Sky series floodlight	Formulating time: 2014-9-12		
Edition	Page number			Amending date:		
A/0	3/8	Model	ZGE-TGD224WB184B-30LF	Approve	Audit	Formulate
六、 Safety requirement:						
Item name		Standard specification				
Logo durability		Wipe the logo with watering cloth for 15 seconds;then wipe it with ethane for 15 seconds after dried,at last check the logo clarity				
Structure		Meet GB7000.1-2007 or IEC60598-1: 2008 Correlated standard				
The Insulated Resistance and Electric Strength after 48H moist test		(1)Moist Test: Any value between humidity 91%~95% & environment temperature 20°C~30°C, keep inside the test box for 48H if temperature difference 1°C ; (2)Bring to DC500V to bear on insulation resistance between electrical parts and metal parts for 1 minute.The Insulated Resistance(I type): Basic insulation $\geq 2M\Omega$, additional insulation $\geq 2M\Omega$, double insulation or reinforced insulation $\geq 4M\Omega$; (3)Bring to 2U+1000V (I type, basic insulation)to bear on insulation resistance between electrical parts and metal parts for lights,the test couldn't appear the flicker or puncture (U=working voltage)				
Leakage current		On working time,the current between power polarity and body case $\leq 0.7mA$ (I class clamp)				
Ground connection rule		More than 10A current producing by Less than 12V floating voltage connects the ground terminal and between all kinds of metal parts seperately, and release the current at least 1min,ground resistance $\leq 0.5\Omega$; contact area connecting with ground should be bare metal surface;yellow-green double colors connect the ground line				
Hot test (regular work)		During the test and the end of the test, the temperature of the tested components shall not exceed the limit				
Electrical shock protection		Insulating paint is not reliable, not as a protective layer against electric shock; not accessible live parts, basic insulation metal parts is difficult to touch; enough mechanical strength, rigid fixation				
Internal and external wiring		Meet the standard requirements(internal connecting conductor $\geq 0.5mm^2$, external connecting conductor $\geq 1mm^2$)				
Creepage distance and electric clearance		PTI<600; creepage distance: basic insulation $\geq 2.5mm$; additional insulation $\geq 3.6mm$; reinforced insulation $\geq 6.5mm$ electric clearance: basic insulation $\geq 1.7mm$; additional insulation $\geq 3.6mm$; reinforced insulation $\geq 6.5mm$				
Power supply terminal disturbance voltage		Test is only for lead-in reference, not mandatory indicators, unnecessary to pass the test				
CE LVD		Y				

Document number:		Products Name	30W Blue Sky series floodlight	Formulating time: 2014-9-12		
Edition	Page number			Amending date:		
A/0	4/8	Model	ZGE-TGD224WB184B-30LF	Approve	Audit	Formulate

七、Optical and electrical test parameter:

光源光谱测试报告

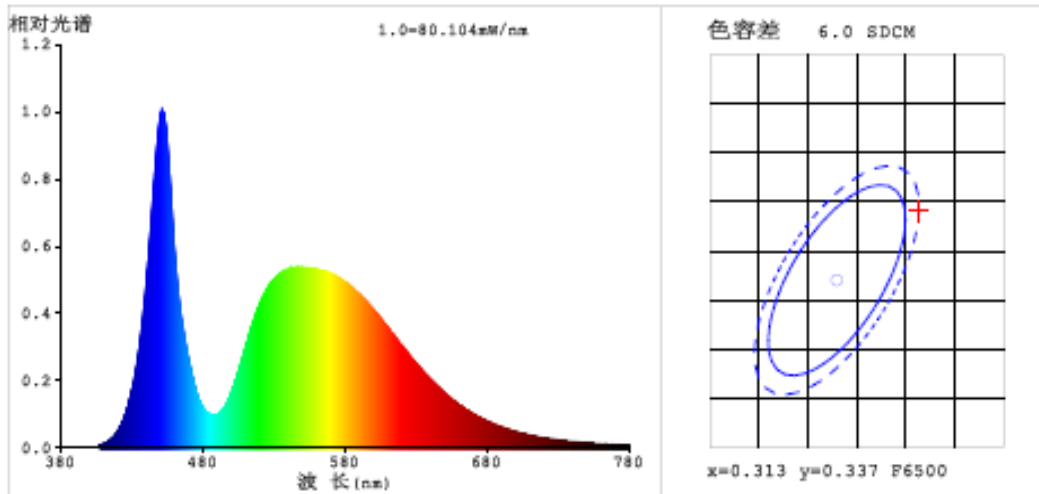

颜色参数:

色品坐标: $x=0.3214$ $y=0.3440$ / $u'=0.1983$ $v'=0.4774$
 相关色温: $T_c=5992K$ (色差 $D_{uv}=0.0065$) 主波长: $\lambda_d=503.9nm$ 色纯度: $Purity=3.6\%$
 红色比: $R=13.3\%$ 峰值波长: $\lambda_p=450.9nm$ 半宽度: $\Delta\lambda_d=21.2nm$
 显色指数: $R_a=70.4$
 R1 =67 R2 =75 R3 =78 R4 =71 R5 =68 R6 =65 R7 =82
 R8 =57 R9 =0 R10=38 R11=66 R12=35 R13=68 R14=88 R15=62

光度参数:

光通量 $\Phi_v = 2589.8 lm$ 光效: $89.30 lm/W$ 辐射通量 $\Phi_e = 7.501 W$

电参数:

电压 $V = 220.8 V$ 电流 $I = 0.1380A$ 功率 $P = 29.00 W$ 功率因数 $PF = 0.9490$
 分级: OUT 白光分类: ANSI_6500K

仪器状态: 积分时间 $T = 9 ms$ $I_p = 51351 (78\%)$

产品型号: ZGE-TGD224WB184B-30LF 产品编号:
 测试人员: 测试日期: 2014-07-30
 环境温度: 30.3℃ 环境湿度: 65.0%
 制造厂商: 广州众恒光电科技有限公司 备注:

Document number:		Products Name	30W Blue Sky series floodlight	Formulating time: 2014-9-12		
Edition	Page number			Amending date:		
A/0	5/8	Model	ZGE-TGD224WB184B-30LF	Approve	Audit	Formulate

八、Surface of light intensity distribution:

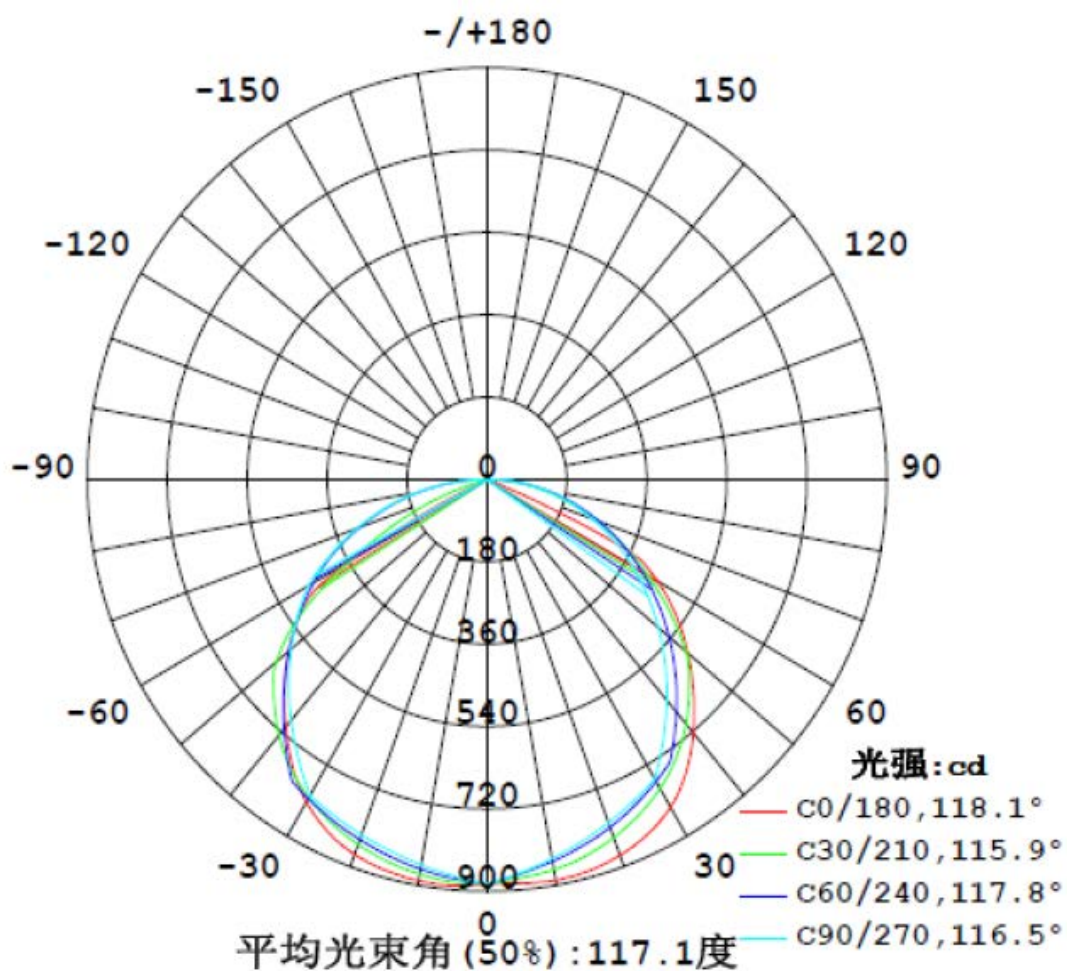

Document number:		Products Name	30W Blue Sky series floodlight	Formulating time: 2014-9-12		
Edition	Page number			Amending date:		
A/0	6/8	Model	ZGE-TGD224WB184B-30LF	Approve	Audit	Formulate

九、Average illumination image:

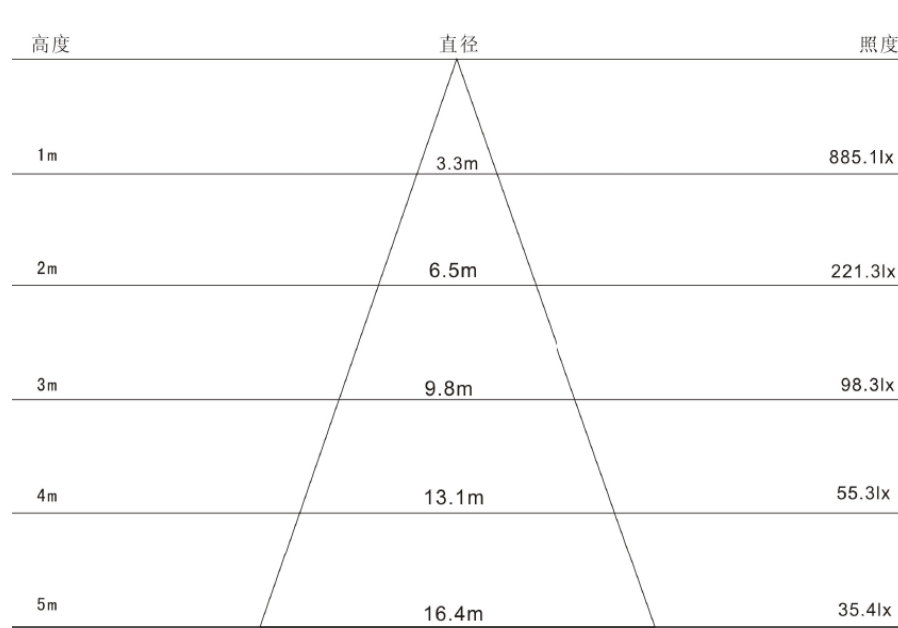

十、Nameplate:

(1) power supply nameplate:

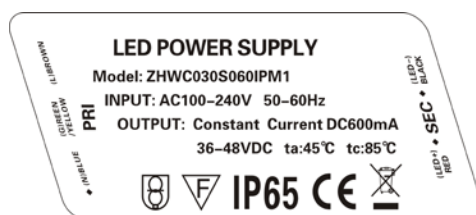

30W 58*24MM

(2) product nameplate:



Remarks:

Product nameplate is adhesive labels, color temperature will according to the order requirement to chose frame filling. Date of printing as per actual production date.

Document number:		Products Name	30W Blue Sky series floodlight	Formulating time: 2014-9-12		
Edition	Page number			Amending date:		
A/0	7/8	Model	ZGE-TGD224WB184B-30LF	Approve	Audit	Formulate

十一、Installation:

Step 1

Opening package, take out lamp and accessories, check the accessories are complete or not, if the glass is damaged please ask for suppliers to replace immediately.

Step 2

Lights can install on the ground、 wall or brackets according to actual situation such as installation on the brackets with hexagonal head screw fixed. And dig the hole on ground or wall with suitable expansion bolt fixing according to light's bracket if install on the ground or wall. As drawing:

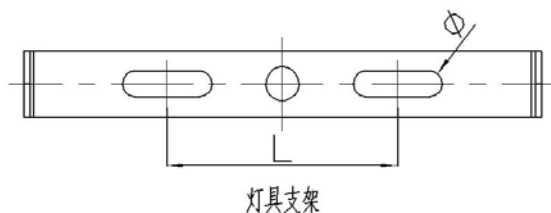

Step 3

After fixing light body, unscrew from both side, then tighten the screws when turns the light to the correct angle

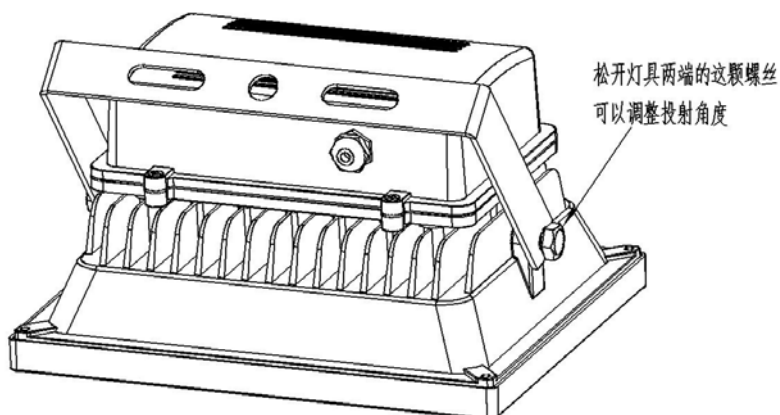

Step 4

Connection line: brown wire connects the fire wire, blue line connects the null line, and yellow-green line connects ground wire.

Document number:		Products Name	30W Blue Sky series floodlight	Formulating time: 2014-9-12		
Edition	Page number			Amending date: 2014-9-25		
A/1	8/8	Model	ZGE-TGD224WB184B-30LF	Approve	Audit	Formulate

十二、Packing:

Package	Dimension(mm)	Box & CTN	Qty	Net\gross weight (Kg)	
Inner box	201*104*229mm	1PCS/boxes	1PCS	1.29	1.43
Outer Carton	427*337*254mm	1 layers/CTN	6PCS	9.22	

十三、Attention:

- 1、 Please take care of glass part when moving;
- 2、 Do not disassemble the lights if not professional;
- 3、 The working power is high voltage alternating current which is installed in out of reach by people,the wire core shall not be exposed while connecting,and do ground protection
- 4、 Place for installation must be carrying capacity enough to ensure the safety;
- 5、 Please don't touch the light cup by hand when working , in order not to be scalded.
- 6、 Working ambient temperature should be less than 45°C .Otherwise, It will effect the lifespan of products.Keep it well;
- 7、 Do not work over the range of voltage to ensure the lifespan of barretter;
- 8、 This product has tri-proof.It can work in rain but couldn't soak into the water;
- 9、 Clear the dust in one time to keep the good heat dispersion. Be noted that do not clear the products with corrosive liquid;
- 10、 Ask for professional to installation or maintaince;

Attention: Won't notice if any information changed. Any doubts please contact supplier directly!